



OPERATOR INSTRUCTIONS SMART CONTROL



Table of Contents

1	General remarks.....	3
1.1	Safety.....	3
1.2	Payload accuracy	3
1.3	Maintenance	3
2	First use.....	4
2.1	Check pre-requisites.....	4
2.2	Check connection.....	4
2.3	Set Company name.....	5
2.4	User settings (optional)	6
2.5	Payload calibration.....	7
2.5.1	Pre-conditions.....	7
2.5.2	Payload calibration	7
3	General use.....	10
3.1	Perform tipping: DASHBOARD.....	11
3.1.1	Normal tipping	11
3.1.2	Auto lowering	13
3.1.3	Body height indication.....	13
3.1.4	Warnings during tipping	14
3.2	Check statistics: STATISTICS.....	15
3.3	Check maintenance: MAINTENANCE.....	16
3.4	Adjust settings: SETTINGS.....	17
4	Update.....	18



1 General remarks

Smart Control is Hyva's tipping control system which manages the unloading cycle of tipping vehicles to make tipping more efficient, safer, and easier. Smart Control will intervene in case of a dangerous situation by stopping tipping ahead of time. To enable live tracking and fleet statistics Smart Control is connected to the OneEMS cloud platform and shares data on location, tipping, and maintenance with that platform.

This manual is intended for the driver who is using Smart Control in a tipper. Before using the system, please read this instruction carefully. Please also read the Operating and Maintenance Instructions for the tipping system.

1.1 Safety

The following safety rules apply for using Smart Control:

- The system is designed to provide measurements and warnings to assist with tipping actions, and is NOT a substitute for tipping with due care and attention
- Always obey tipper operating instructions, local regulations, signs and applicable laws. Distracted tipping can be extremely dangerous.

1.2 Payload accuracy

One of the features of Smart Control is a payload indication. This payload indication has up to 3% accuracy under the following conditions:

- The truck must be provided with a tipping kit supplied by Hyva;
- The Smart Control system must only contain parts supplied by Hyva or a Hyva certified dealer;
- The system is installed according to the Smart Control mounting instructions;
- The "Set value" menu must be filled in with accurate data provided from CAD data or accurate measurements;
- A sensor calibration must be performed with the truck parked on a flat surface (within 1 degree in lat. and long. direction) for the system;
- A payload calibration must be performed (as described in chapter 2.5) with accurate weight filled in provided by a calibrated weighing bridge in order to reach accuracy targets;
- The load during operation has the same substance & distribution as during the payload calibration;
- The body is (fully) loaded during operation in the same way as during the payload calibration;
- The truck is on flat ground (within 1 degree in lat. and long. direction) during tipping;
- The payload is measured either static or dynamically within the weighing zone (3~4 degrees)

1.3 Maintenance

A number of features of Smart Control are related to maintenance of the cylinder. For these maintenance items, statistics are calculated by Smart Control about days of usage, number of tipplings, amount of payload unloaded, etc which are compared to standard intervals and maintenance needs.

2 First use

This section describes how to get the Smart Control running on your display.

2.1 Check pre-requisites

To be able to use the functionality of Smart Control installed on a truck you will need the following:

- Smart Control installed on a tipper, consisting of a Controller, Gateway, Display, various sensors and a wiring harness. Please refer to **Smart Control Body builder instructions** on how to install the system.

The app looks like the Figure 1 Main menu below and contains the following visual components:

Hyva header on the top, that contains the name of the company, the license plate of the system, the connection status, and a back button.

Main menu items: dashboard, statistics, maintenance, and settings are described in chapter 3.

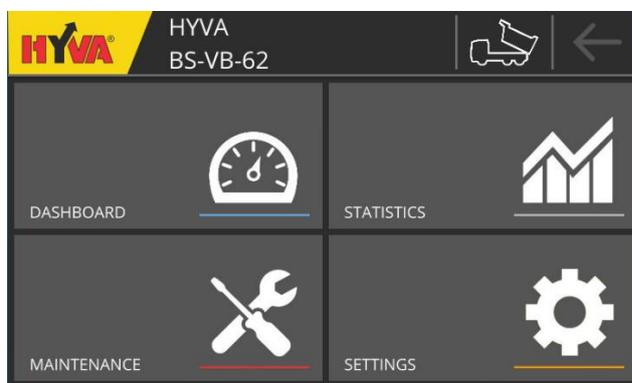

FIGURE 1 MAIN MENU

2.2 Check connection

The first step is to check the connection to the system on the truck.

In normal condition the dashboard screen should look like Figure 2. The display is receiving sensor data from the system.

If standing still:

- Vehicle angle is shown (if there is GPS reception)
- Side angle is shown (if there is GPS reception)
- Back button is white
- Truck icon is white

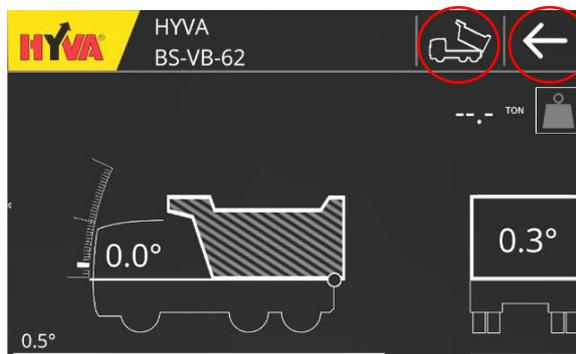

FIGURE 2 NORMAL CONDITION

2.3 Set Company name

The app uses the company name and license plate number. The license plate number is used to distinguish between different trucks of the same company. Please use the following steps to set the company name:

From the main menu (Figure 3) select the Settings menu.

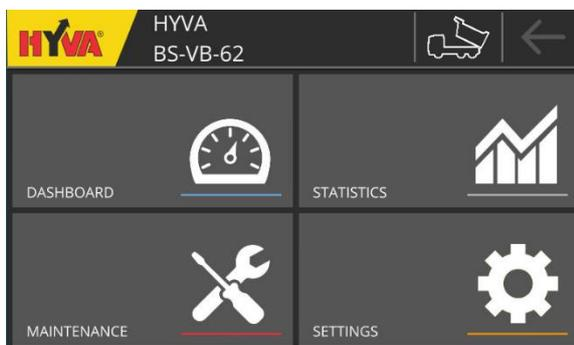

FIGURE 3 MAIN MENU

From the Settings menu (Figure 4) select the Company information menu.



FIGURE 4 SETTINGS

Fill in the company name and press Enter (as shown in Figure 5).

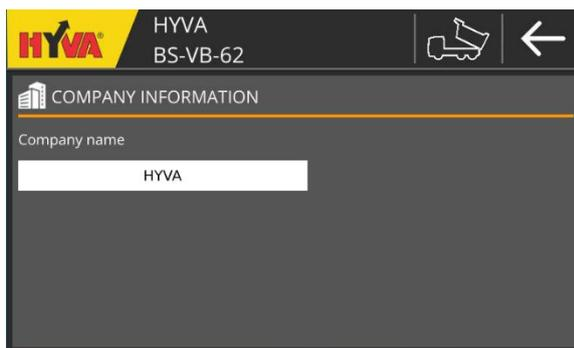

FIGURE 5 COMPANY INFORMATION



2.4 User settings (optional)

In the app you can switch between metric and imperial units. Please use the following steps to set the units:

From the main menu (in Figure 6) select the Settings menu.

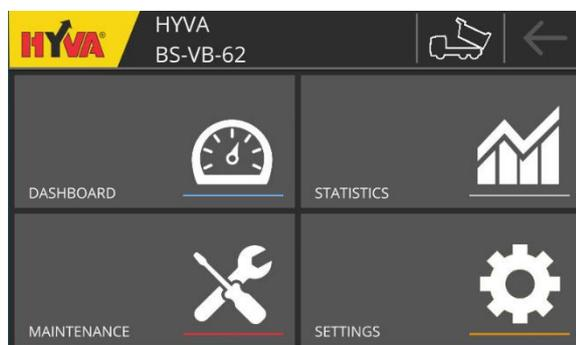

FIGURE 6 MAIN MENU

From the Settings menu (in Figure 7) select the User settings menu.

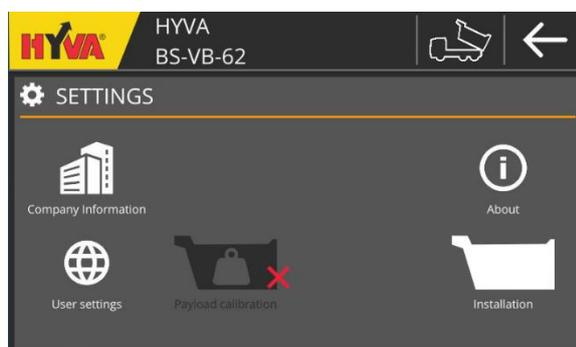

FIGURE 7 SETTINGS

Check Imperial for imperial units or uncheck for metric units (as shown in Figure 8).



FIGURE 8 UNITS SELECTION



2.5 Payload calibration

2.5.1 Pre-conditions

1. Check if the body is totally empty
2. Measure the weight of the empty truck on a weighbridge. Write this weight number down.
3. Fill the body completely with load (realistic amount of the most common load for this truck and normally distributed).
4. Measure the weight of the loaded truck on a weighbridge. Write this number down as well.
5. Put the truck on equal (+/- 1 degree) ground on a place where a tipping cycle can be performed (not more than a few degrees needed). **Do not unload the truck.**

2.5.2 Payload calibration

Follow the steps from below. Make sure the preconditions are done.



Warning: do not unload the truck before or during the payload calibration.



From the Main menu (Figure 9) click on Settings.

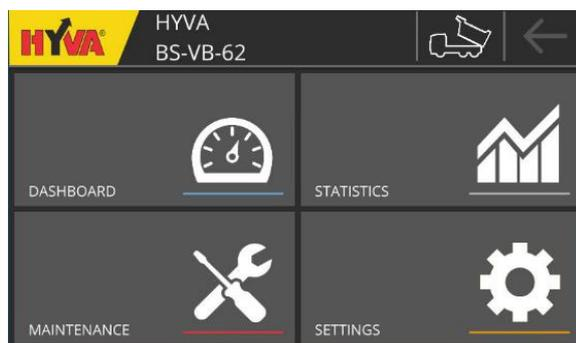

FIGURE 9 MAIN MENU

From the Settings menu (Figure 10) select the Payload calibration menu. Follow the instructions in the Smart Control. After completing a step, please click the arrow to proceed to the next step.

[From the installation menu, payload calibration can also be performed.]

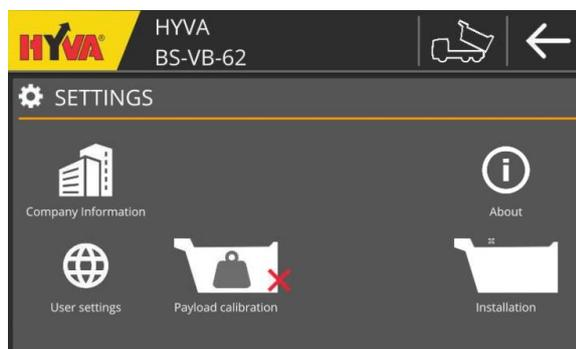

FIGURE 10 SETTINGS

Step 1 (Figure 11): fill in the total weight of the truck without payload. Enter the total weight in the text box.

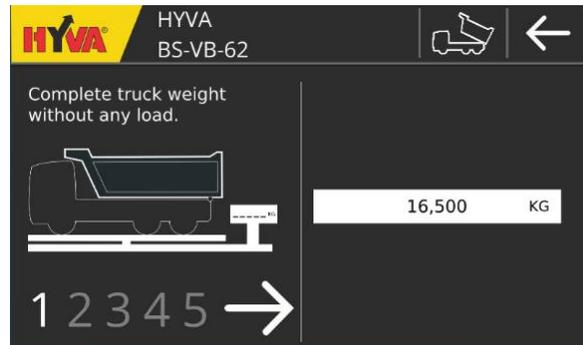

FIGURE 11 PAYLOAD CALIBRATION - STEP 1

Step 2 (Figure 12): fill in the total weight of the truck with payload. Enter the total weight in the text box.

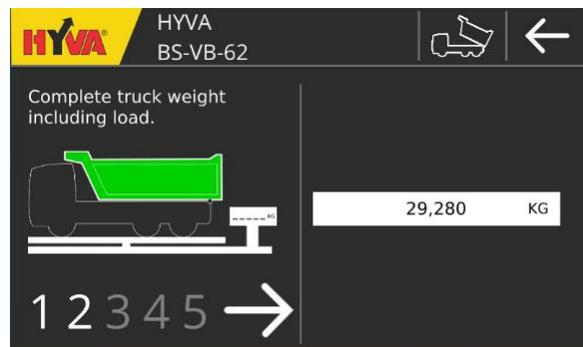

FIGURE 12 PAYLOAD CALIBRATION - STEP 2

Step 3 (Figure 13): tip the filled body till the area stated in the screen [3 – 4°] (when calibration is done, next step appears automatically).

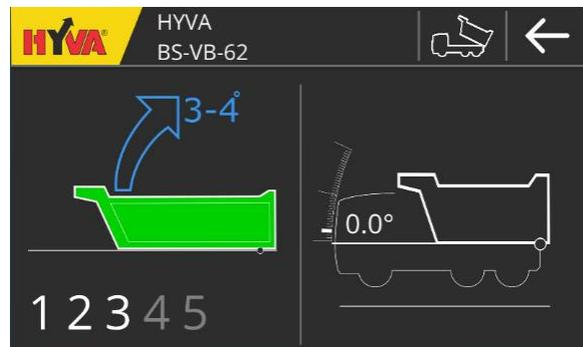

FIGURE 13 PAYLOAD CALIBRATION - STEP 3



Warning: the body should be tipped and lowered with stationary engine speed for an accurate configuration

Step 4 (Figure 14): lower the body back on the chassis.

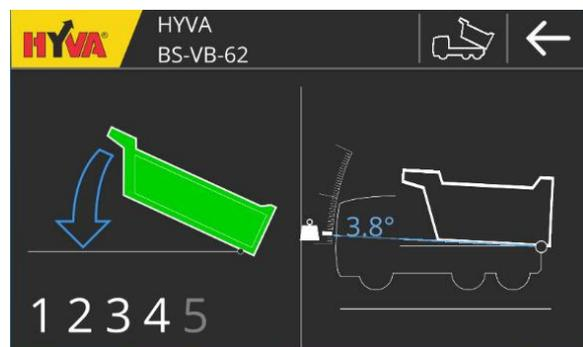

FIGURE 14 PAYLOAD CALIBRATION - STEP 4

Step 5 (Figure 15): Wait till synchronizing is complete.

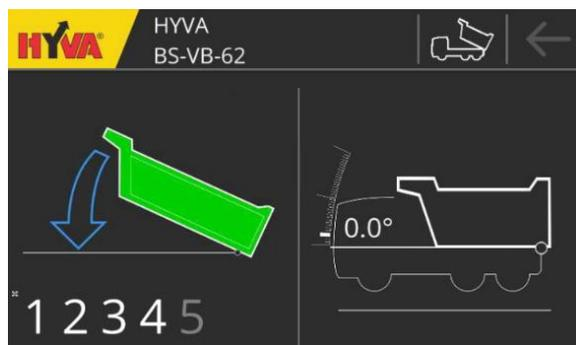

FIGURE 15 PAYLOAD CALIBRATION - SYNCHRONIZING

Step 5 (Figure 16): payload calibration is done.

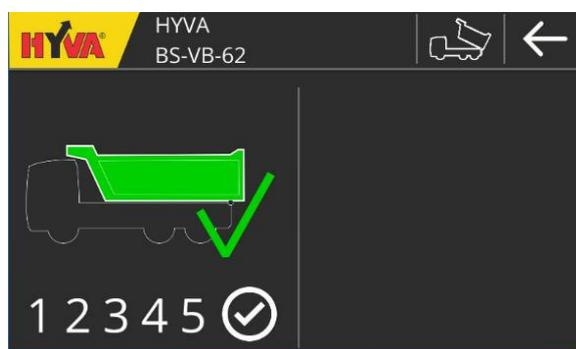

FIGURE 16 PAYLOAD CALIBRATION – STEP 5

In case the payload calibration failed (Figure 17) a red cross is visible. In that case, please perform the payload calibration again with increased tipping speed in step 3 by adding 200 RPM upon the stationary RPM.

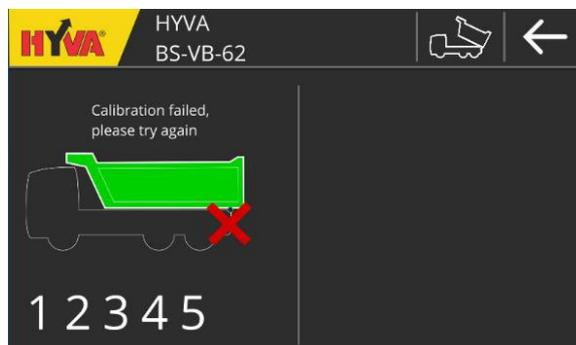

FIGURE 17 PAYLOAD CALIBRATION - FAILED



3 General use

Once the app has been setup for first use, the features of the system can be used.

The top bar of the app contains the information shown in Figure 18:

- Company name configured in the settings.
- License plate of the connected truck as configured in the Smart Control system.
- Connection status (white is connected; grey is disconnected):
 - Truck: Connection to the controller to receive sensor data
- Back button: Using this button, the display goes back to the previous menu.

The main menu items of the app are described in the remainder of this chapter:

Dashboard with tipping information and safety warnings
(Described in section **3.1**)

Statistics overview of the performed tipping's
(Described in section **3.2**)

Maintenance of the truck and status of the system
(Described in section **3.3**)

Settings of the system
(Described in section **3.4**)

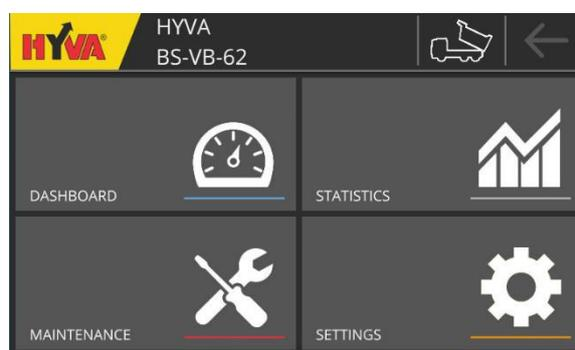

FIGURE 18 MAIN MENU



3.1 Perform tipping: DASHBOARD

The dashboard supports the tipping actions by providing safety warnings and payload indications.

- This payload indication will stay in the dashboard until the body starts lowering close to end of stroke.
- In case of buckling a warning is displayed as shown in Figure 32.
- Once the body is back at rest the dashboard will show the situation in Figure 19.

3.1.1 Normal tipping

When the body is at rest the dashboard looks like Figure 19.

- Vehicle angle is shown (0.5 degree in Figure 20)
- Side angle is shown (0.3 degree in Figure 20)
- Back button is white

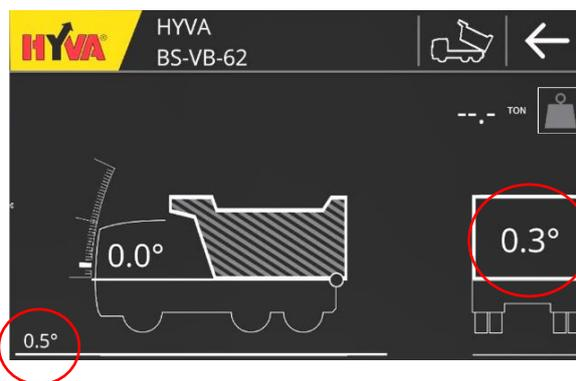

FIGURE 19 DASHBOARD

Once the body starts tipping, the dashboard shows the moving angle of the body Figure 20.

The body is diagonal grey striped because the weight is unknown.

During tipping, a recommended driving speed is shown. This driving speed is related to the tipping angle.

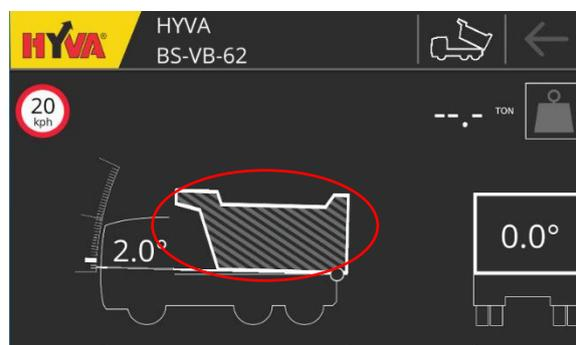

FIGURE 20 START OF TIPPING

When the angle of the body is between 3 and 4 degrees, the app will measure the payload in the body as shown in Figure 21.

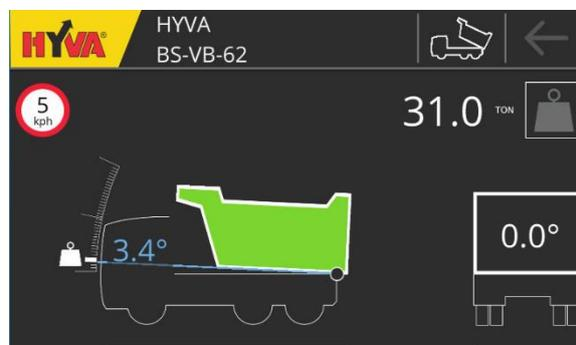

FIGURE 21 WEIGHING ZONE

On the right side of the display, the side angle of the body is shown.

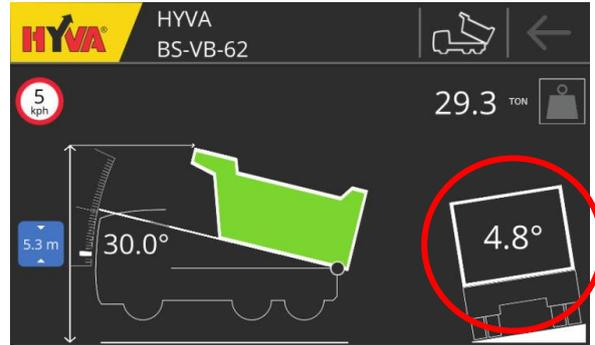

FIGURE 22 TIPPING WITH SIDE ANGLE

When the body is at end of stroke (Figure 23), it is not possible to tip, only lowering is possible.

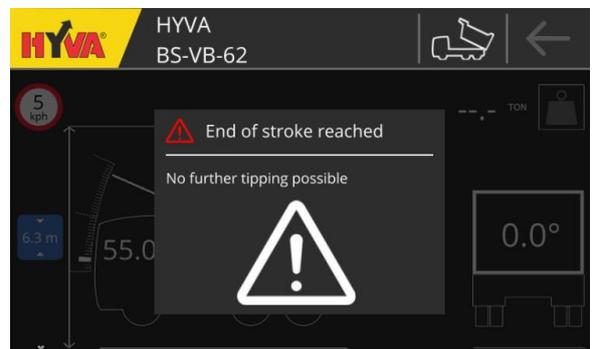

FIGURE 23 END OF STROKE - KNOCK OFF

The body shall be green striped (Figure 24), when there is residual load inside the body. The system does not know the exact weight. This weight will be calculated in the weighing zone.

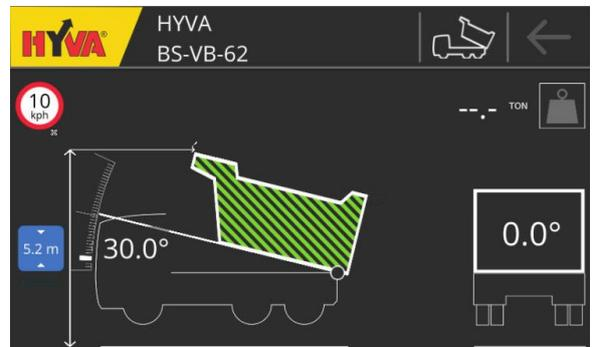

FIGURE 24 RESIDUAL LOAD

Once the tipping is ended (means body is back on the chassis), then a tipping summary is shown (Figure 25).

This tipping summary concludes the total payload, unloaded mass, payload left over and tipping time.

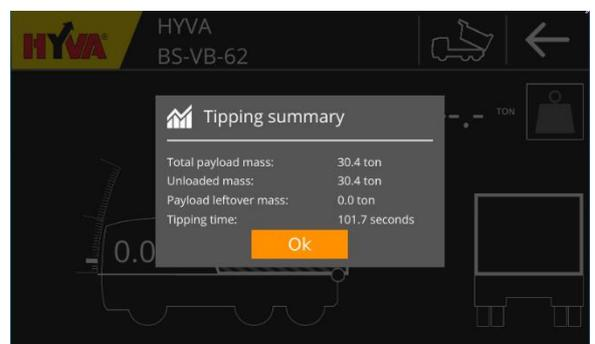

FIGURE 25 TIPPING SUMMARY

3.1.2 Auto lowering

To lower the body, Auto lowering can be used. To activate Auto-lowering tap **2 times** the joystick to the lowering position.

If Auto-lowering is enabled (see Figure 26) a warning sign is shown on the display and sound signal is present.

To abort Auto-lowering press the joystick up / down.



FIGURE 26 AUTO LOWERING

3.1.3 Body height indication

Once the system is in tipping mode, a body height indication is shown of the left side of the display (Figure 27)



FIGURE 27 BODY HEIGHT INDICATION START OF TIPPING

When the body angle increase, the body height indication also increases (see Figure 28).

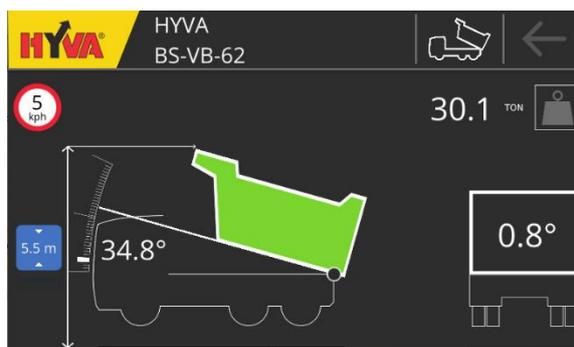

FIGURE 28 BODY HEIGHT INDICATION 35 DEGREES



3.1.4 Warnings during tipping

Overloaded

If the body is overloaded, the body will become red. There will be an acoustic signal to warn the truck driver if the body is overloaded.

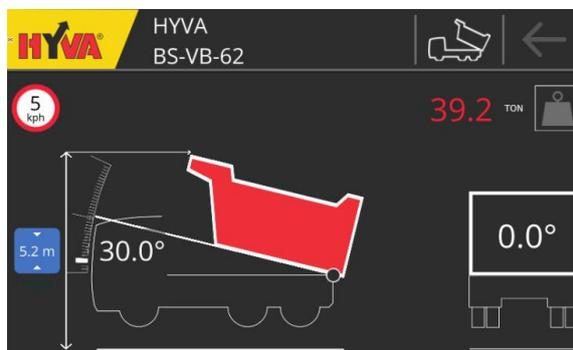

FIGURE 29 OVERLOAD

Topple over

A Side load warning (Figure 30) is an indication that there is a risk to topple over. The system warns you to stop your tipping and carefully lower the body slowly and relocate the truck before tipping

When the pop up Topple-over risk is showed (Figure 31), the body can only by lowered.

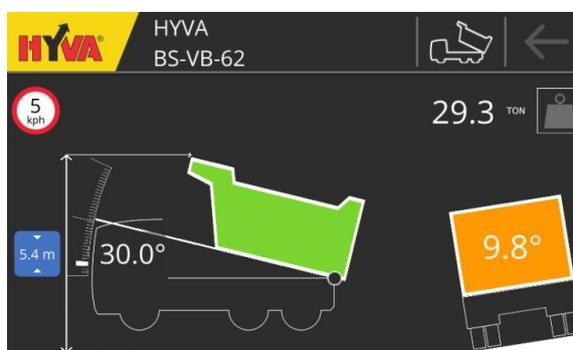

FIGURE 30 SIDE LOAD WARNING



FIGURE 31 TOPPLE OVER

Buckling

If pressure exceeds the threshold for the cylinder, a buckling warning (Figure 32) is given.

The system advice to lower the body.

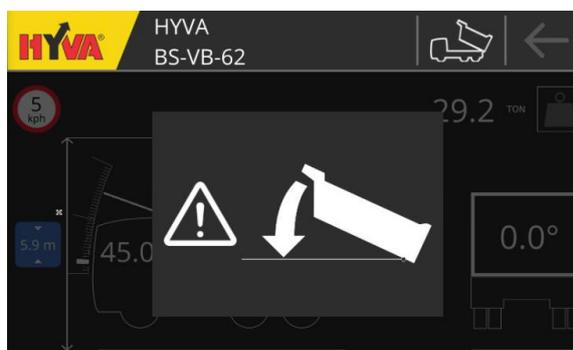
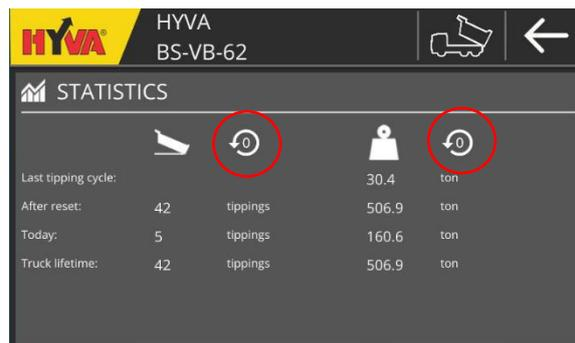

FIGURE 32 BUCKLING

3.2 Check statistics: STATISTICS

The statistics screen gives an overview of the number of tipplings and the total amount of payload measured:



The **left** column shows the number of tipping's
The **right** column shows the weight carried.
The reset buttons (Figure 33) can be used to reset the 'after reset' counters.

FIGURE 33 STATISTICS



3.3 Check maintenance: MAINTENANCE

The maintenance screen indicates the status of the system and any required maintenance for the cylinder.

The left column displays the status of the individual sensors (as shown in Figure 34)

The right side of the screen shows the maintenance status of the cylinder parts (as shown in Figure 34).

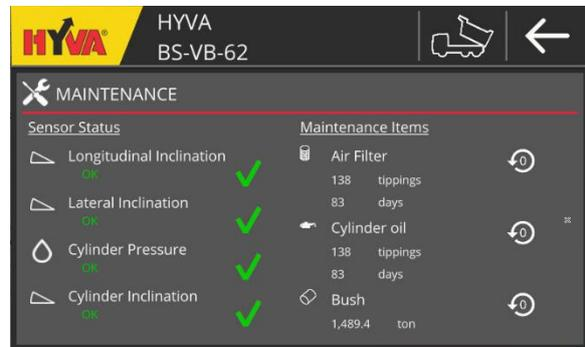

FIGURE 34 MAINTENANCE SCREEN – NO ISSUES

When a part needs to be maintained, a sign will be visible on the main menu page (Figure 35).

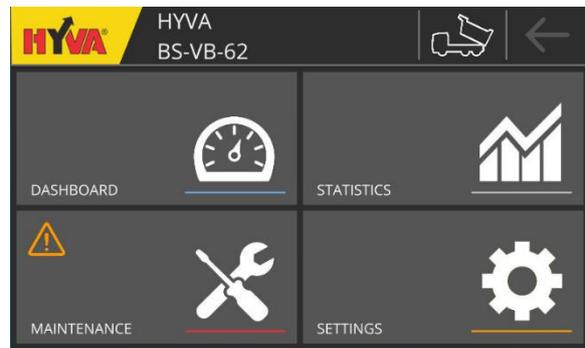

FIGURE 35 MAIN MENU - MAINTENANCE WARNING

In the maintenance screen, it is visible which part needs to be checked or maintained.

After checking the parts which needs to be maintained, the counter can be reset by pressing the reset button.

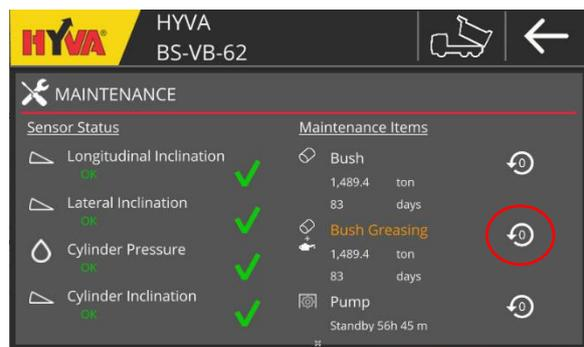

FIGURE 36 MAINTENANCE SCREEN - WARNING



3.4 Adjust settings: SETTINGS

The settings menu can be used to personalize the app and to calibrate the system:

Company information: Set the company name (described in section 2.3)

User settings: Select the measurement units (described in section 2.4)

Payload calibration: Calibrate the system for a specific type of payload (described in section 2.7)

Installation: Install a new system (by a body builder).
This menu should only be used by specialized engineers after reading Smart Control mounting instructions.

About: The current software version is shown here.

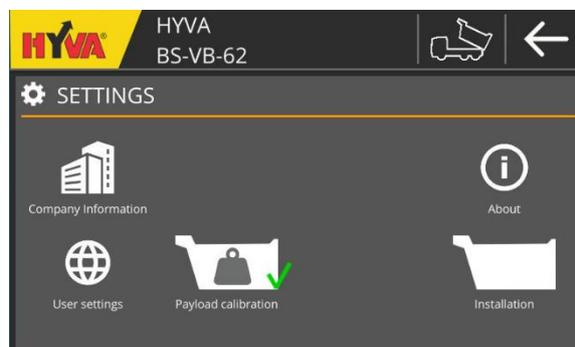

FIGURE 37 SETTINGS SCREEN

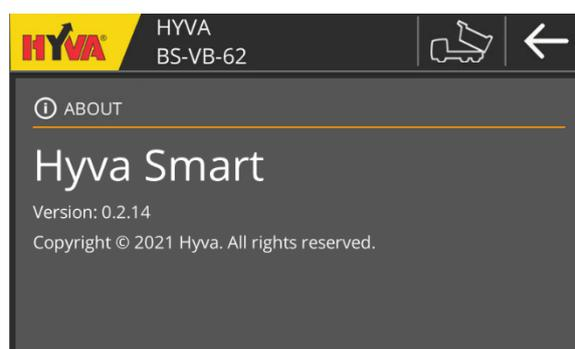

FIGURE 38 SETTINGS - ABOUT



4 Update

The firmware can be updated over the air (FOTA). Once there is an update available, a pop up will be shown (in Figure 39).

This pop up will only be visible if the truck is not tipping.

The update can be postponed or installed. If the update is postponed, the pop up will be back after a certain time.

The update will take maximum 30 minutes.

The update can only be performed by a service station.

Please contact a service station to update the system.



FIGURE 39 FOTA UPDATE AVAILABLE



FIGURE 40 ENTER PASSWORD

