

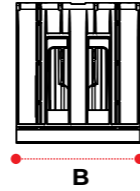
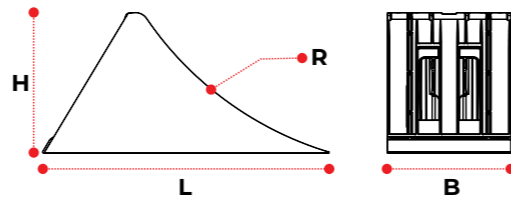
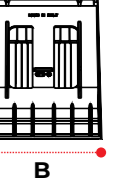
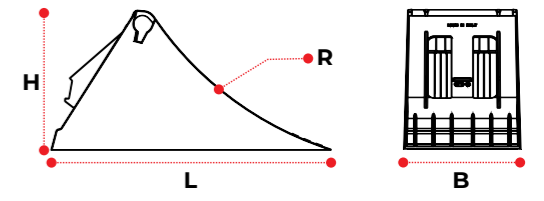

WHEEL CHOCKS

CROWNY HEAVY 53
YELLOW HOMOLOGATED THERMOPLASTIC CHOCK

Part No.	Length (mm)	Breadth (mm)	Height (mm)	Radius (mm)	Weight (Kg)	Box	Pallet
600120100	467	201	230	555	1.81	8	192
600120200	467	201	230	555	1.66	8	192

CROWNY 46
YELLOW HOMOLOGATED THERMOPLASTIC CHOCK

Part No.	Length (mm)	Breadth (mm)	Height (mm)	Radius (mm)	Weight (Kg)	Box	Pallet
600100100	383	160	190	460	0.88	10	280
600100200	383	160	190	460	0.75	10	280

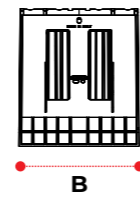
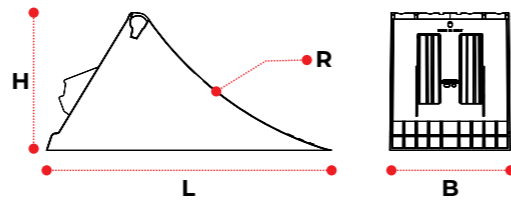
CROWNY 53
YELLOW HOMOLOGATED THERMOPLASTIC CHOCK

Part No.	Length (mm)	Breadth (mm)	Height (mm)	Radius (mm)	Weight (Kg)	Box	Pallet
600110100	467	198	225	555	1.35	8	192
600110200	467	198	225	555	1.19	8	192

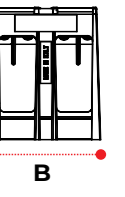
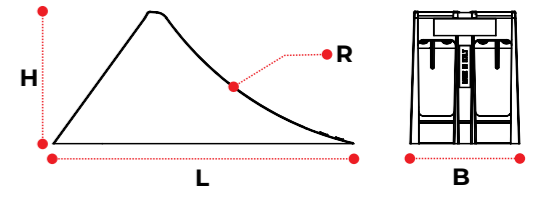
CROWNY 36
YELLOW HOMOLOGATED THERMOPLASTIC CHOCK

Part No.	Length (mm)	Breadth (mm)	Height (mm)	Radius (mm)	Weight (Kg)	Box	Pallet
600090100	336	123	148	355	0.49	20	520
600090200	336	123	148	355	0.40	20	520

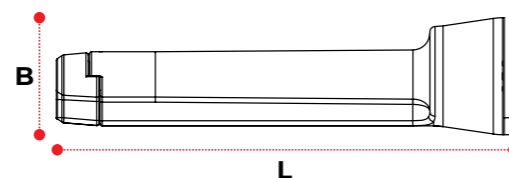
KLOK
PLASTIC FIXING SUPPORT FOR CHOCK
NEST
PLASTIC CHOCK HOLDER 90° FAST CHASSIS-FITTING

Part No.	Length (mm)	Breadth (mm)	ⓘ	Weight (Kg)	Box
600250100	215	55	G46 / small	0.15	30
600250300	258	55	53 / big	0.15	24

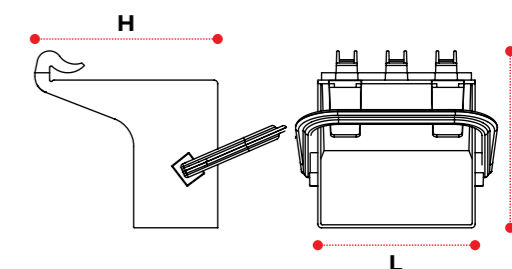

Part No.	Length (mm)	Breadth (mm)	Height (mm)	ⓘ	Weight (Kg)	Box	Pallet
600190100	217	244	252	53 / big	1.07	16	160

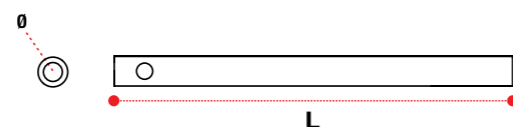
ROUNDY
ZINC PLATED FIXING SUPPORT WITH SCREW FOR PLASTIC CHOCK
NEST
PLASTIC CHOCK HOLDER 130° FAST CHASSIS-FITTING

Part No.	Length (mm)	Ømm	Weight (Kg)	Box	Pallet
600260100	250	21	0.52	4	40

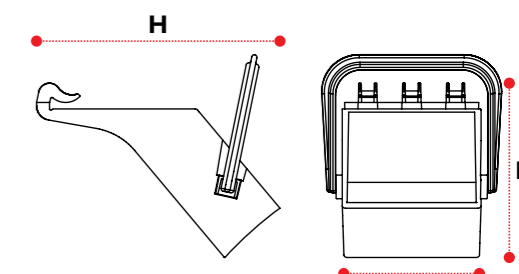

Part No.	Length (mm)	Breadth (mm)	Height (mm)	ⓘ	Weight (Kg)	Box	Pallet
600190200	210	270	377	53 / big	1.15	16	160

HOST
PLASTIC CHOCK HOLDER

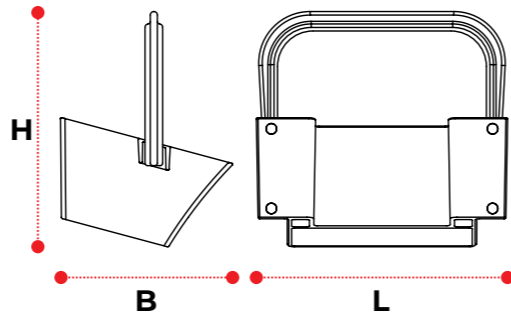

Part No.	Length (mm)	Breadth (mm)	Height (mm)		Weight (Kg)	Box	Pallet
600150100	184	194	128	G46 / small	0.45	10	340
600180100	213	183	137	53 / big	0.44	8	272

BEGIN
HOT GALVANIZED CHOCK HOLDER

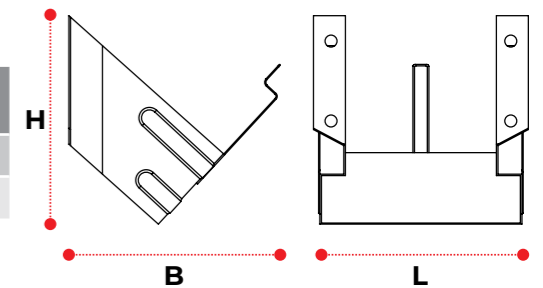

Part No.	Length (mm)	Breadth (mm)	Height (mm)		Weight (Kg)	Box	Pallet
600160200	165	127	167	G46 / small	0.53	20	520
600170200	208	171	228	53 / big	0.98	32	320

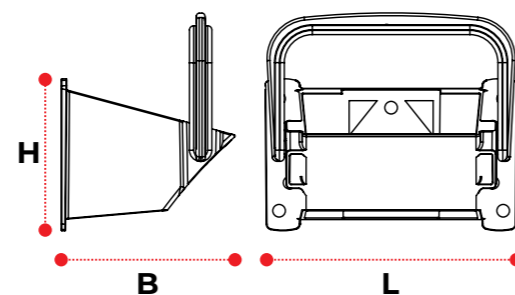
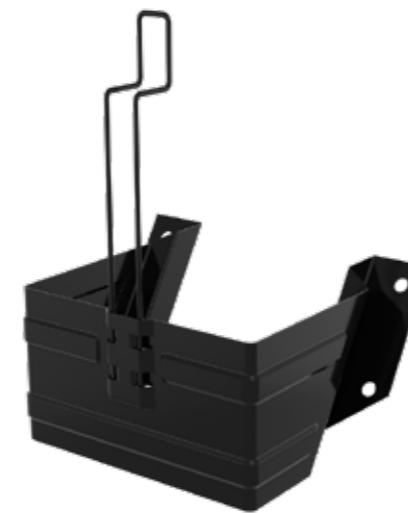
DOUBLE
PLASTIC CHOCK HOLDER 36

Part No.	Length (mm)	Breadth (mm)	Height (mm)	Weight (Kg)	Box	Pallet
600210100	133	124	109	0.17	20	680

BEGIN
BLACK POWDER COATED CHOCK HOLDER

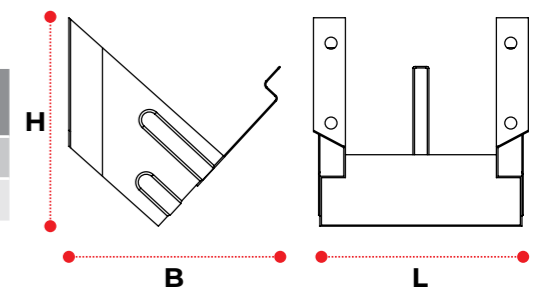
Part No.	Length (mm)	Breadth (mm)	Height (mm)		Weight (Kg)	Box	Pallet
600160300	165	127	167	G46 / small	0.53	20	520
600170300	208	171	228	53 / big	0.88	32	320



110 countries
+3,500 employees
20,000 customers
+30 subsidiaries
12 production facilities



Hyva is a leading provider of innovative and highly efficient transport solutions for commercial vehicles used in transport, construction, mining, materials handling and environmental service industries.

Founded in 1979 in the Netherlands, the company has a global presence with more than 30 wholly owned subsidiaries, extraordinary service coverage and 12 manufacturing facilities in Brazil, China, Europe and India.

For more information on Hyva, please visit www.hyva.com

or follow us on:



Hyva Holding B.V
Antonie van Leeuwenhoekweg 37
2408 AK Alphen aan den Rijn
The Netherlands
Telephone: +31 (0)172 - 42 35 55
Telefax: +31 (0)172 - 42 08 80
info@hyva.com
www.hyva.com



Quality and
environmental certified

DEALER STAMP