

EDGE LINE
RAISE YOUR GAME



ARTICULATED CRANES WITH ULTIMATE PRECISION AND LIFTING CAPACITY

HC 265e 



RAISE YOUR GAME HYVA PERFORMANCE

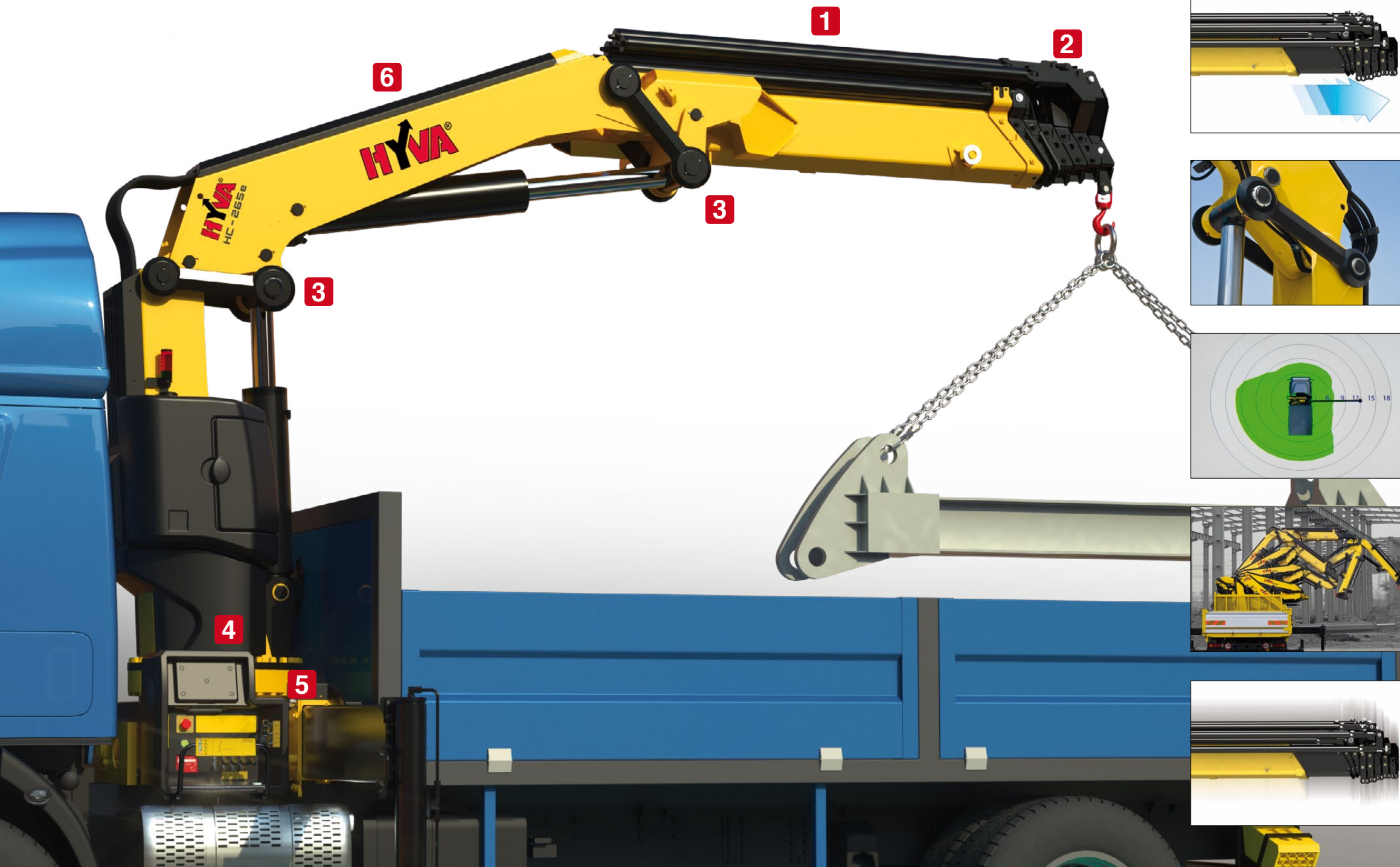

TOP SOLUTIONS

1 TPP

- **Top protection painting** - Top quality cathaphoresis treatment and paint process on all crane components ensures higher value retention and durability.
- Bolts and nuts protected by Geomet[®] treatment: 890% more resistance against corrosion.

Top quality protection for harsh environment



2 EES

- **Extra Extension Speed** - The market is always demanding more speed along with the highest possible safety. EES is the answer. Through the use of a specially designed counterbalance valve, this system increases the extension speed without affecting the crane's safety.

Save time, precise work, increase efficiency

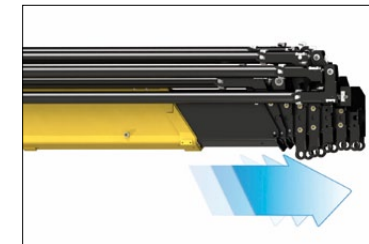

3 LAS

- **Liftrod Articulating System** - Joins forged double linkages on the column and second boom. Its design raises the mechanical advantage of the articulation to provide consistent force through all working angles.

Precision and versatility for all working positions



4 DLD

- **Dynamic Load Diagram** - After the stabilization, operator can select the load to be lifted. Display shows the permitted crane outreach based on the stability and the load selected.

Crane lifting capacity always under control in all stabilizer positions

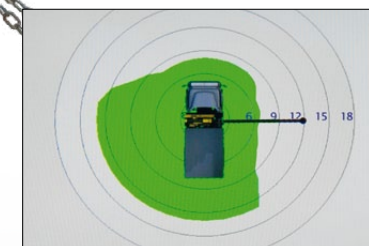

5 MT

- **Magic Touch System** - Allows the driver to open the crane from transport position to working position and back by pushing a single lever on the radio transmitter (or a button on the display).

Crane Automatic folding/unfolding



6 SDS

- **Smooth Descent System** - Uses a special counterbalance valve to reduce boom oscillation, the result for the user is incredible precision in unloading operations.

Control and precision of the movement



TECHNICAL SOLUTIONS TO RAISE RELIABILITY AND SAFETY

Safety first: always stable



- More than 40 stabilizer configurations to ensure safe positioning of the truck in all ground conditions.
- Automatic turning stabilizers are the smart solution. Equipped with a double effect cylinder, they provide effortless movement.

Endless performance: extreme flexibility



- Endless slewing allows the crane to be operated without restrictions. The complete access to the working area, eliminates the need to reposition the truck, optimizing precision, productivity and safety.

Electronics in mind: guaranteed in all conditions



- All electrical components have IP69K enclosures which offer complete protection against water jet and dust penetration providing higher durability and less down time.

Safety Performance Efficiency



H3XL

With a 3" TFT display and ergonomic keyboard, the crane operator can select optimum functional parameters. The system controls the stability with 3-steps beam outreach monitoring (cranes with hydraulically controlled stabilizers) or with 2-steps beam outreach monitoring (cranes with manually controlled stabilizers) and continuous slewing control.



H4XL

A 7" colour display with integrated keyboard gives the operator a higher level of awareness of the crane operation and allows selection of the best parameters for effective use. The system detects the exact position of the beams and proportionally calculates the stability.

SMART AND USER-FRIENDLY CONTROLS

Control station distinguished by operator comfort and user-friendly interface derived from dedicated ergonomic and user preference studies

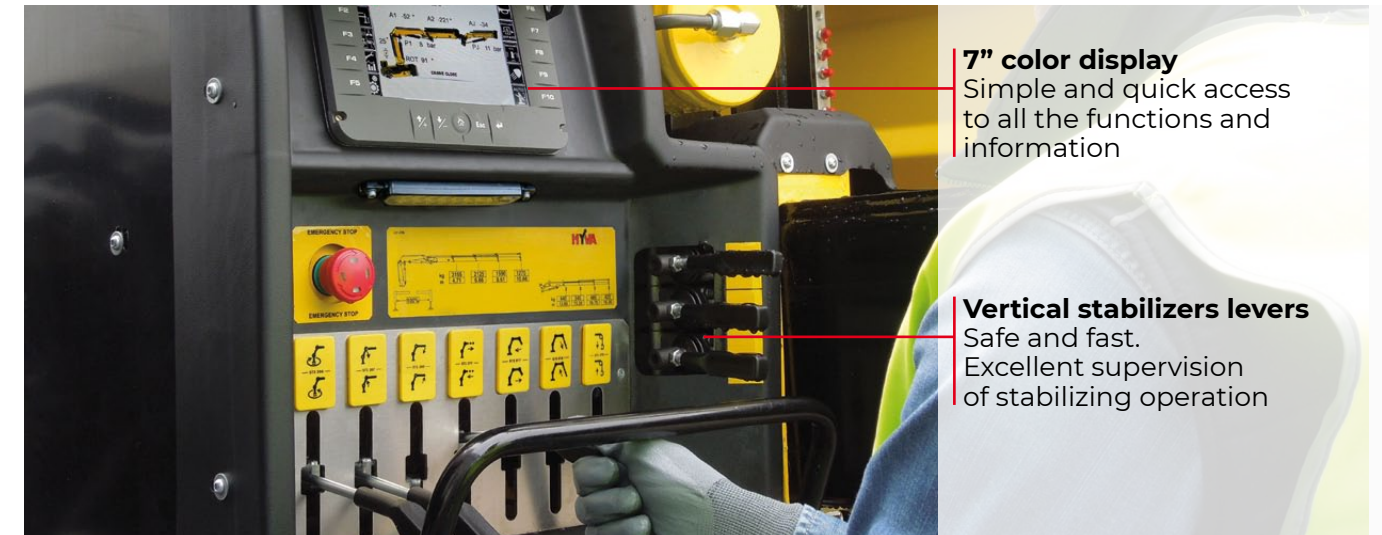

7" color display
Simple and quick access to all the functions and information

Vertical stabilizers levers
Safe and fast. Excellent supervision of stabilizing operation

OUR INNOVATIONS ARE CHANGING THE GAME

Solutions that are the result of smart engineering

DLD DYNAMIC LOAD DIAGRAM



This system, a first on truck-mounted articulated cranes, optimises stabilization, makes crane operation safer and more efficient and allows the driver to verify in advance the crane lifting capacity based on truck stability. A graphic display shows the outreach available for the load selected and the actual boom slewing position.

MT MAGIC TOUCH



This easy-to-use function improves driver attention, promotes safety, saves time and increases productivity. Once the truck is stabilized, a graphic display allows the driver to automatically unfold the crane to a working position and fold the crane from any position to transport position.

Wide range Radio selection (Standard)



Hetronic NOT CE



Hetronic CE Basic



Scanreco



Hetronic CE Graphic



distributor
Danfoss

A TEAM OF SKILLED AND CARING SPECIALISTS

Easy installation and smart calibration cranes, combined with a high level of service, make Hyva the best partner for your business - all over the world



ONE CRANE, MANY APPLICATIONS

Thanks to the extensive range of accessories and attachments



Building



Construction



Energy



Environment



Gardening



Logistics



Maintenance



Mining



Oil&Gas



Rental

TECHNICAL INFORMATION HC265e X

Dimensions (mm)

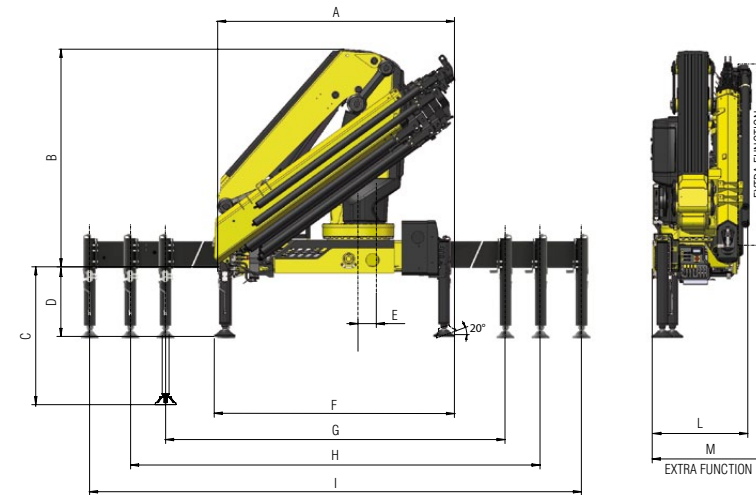

	E2	E3	E4	E5	E6	E7	E8	E4J3	E5J3	E6J2
A	2530	2530	2530	2530	2530	2530	2530	2575	2550	2540
B	2335	2335	2335	2335	2335	2335	2335	2700	2595	2580
C	1348	1348	1348	1348	1348	1348	1348	1348	1348	1348
D	666	666	666	666	666	666	666	666	666	666
E	250	250	250	250	250	250	250	250	250	250
F	2520	2520	2520	2520	2520	2520	2520	2520	2520	2520
G	4860	4860	4860	4860	4860	4860	4860	4860	4860	4860
H	5500	5500	5500	5500	5500	5500	5500	5500	5500	5500
I	7420	7420	7420	7420	7420	7420	7420	7420	7420	7420
L	980	980	980	980	980	1055	1055	1100	1100	1100
M	1100	1100	1100	1100	1100	1130	1130	-	-	-

Load diagrams

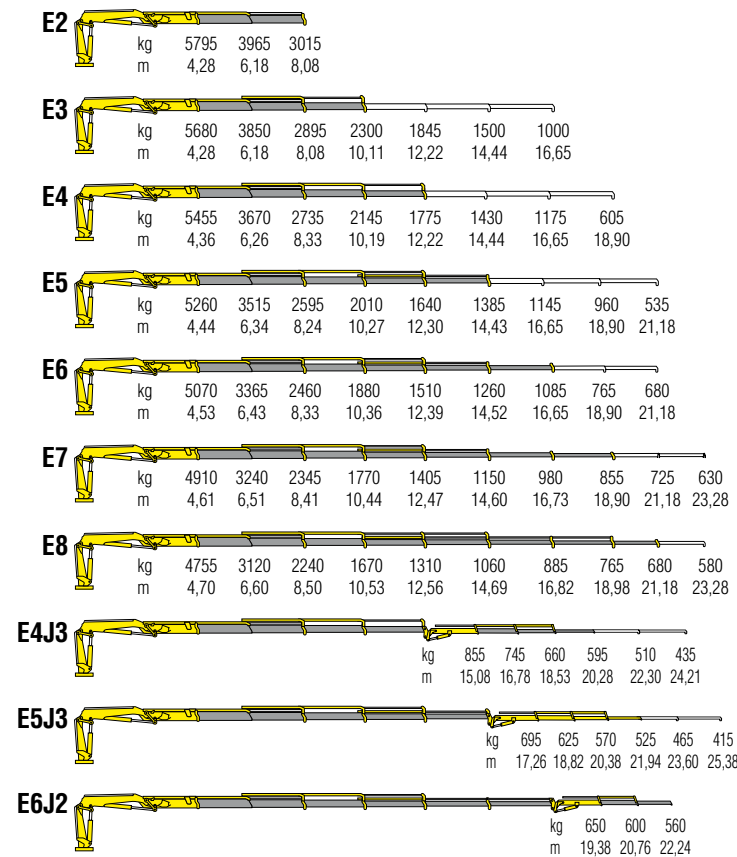

Standard features

Designed in accordance with EN12999

Design class: HC1-HD5

- Multifunctional radio remote control
- Sauer Danfoss PVG32
- P-LCS Proportional Lift Control System
- Flanged valves
- Manually extendable stabilizers
- Fixed stabilizer cylinders
- Swivel stabilizer foot
- Centralized greasing system
- EES Extra Extension Speed
- SDS Smooth Descent System
- LAS Liftrod Articulating System
- H3XL Crane control system (CE)

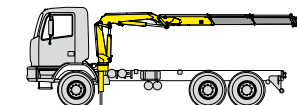

Recommended truck
M.T.T. ton 18 - G.V.W. ton 18

Technical specifications - EN12999 - HC1-HD5

		E2	E3	E4	E5	E6	E7	E8	E4J3	E5J3	E6J2
Lifting Moment	tm	24,8	24,3	23,8	23,3	22,9	22,6	22,3	12,9	12,0	12,6
Slewing Angle	°	endless	endless	endless	endless	endless	endless	endless	endless	endless	endless
Working pressure	bar	345	345	345	345	345	345	345	355	355	355
Oil tank capacity	l	130	130	130	130	130	130	130	130	130	130
Max Oil flow	l/min	80	80	80	80	80	80	80	80	80	80
Max lifting height	m	10,40	12,40	14,50	16,70	19,00	21,20	23,50	22,70	24,20	24,50
Standard crane weight	kg	2745	2885	3025	3150	3255	3375	3465	3685	3640	3530

110 countries
+3,500 employees
20,000 customers
+30 subsidiaries
12 production facilities



Hyva is a leading provider of innovative and highly efficient transport solutions for commercial vehicles used in transport, construction, mining, materials handling and environmental service industries.

Founded in 1979 in the Netherlands, the company has a global presence with more than 30 wholly owned subsidiaries, extraordinary service coverage and 12 manufacturing facilities in Brazil, China, Europe and India.

For more information on Hyva, please visit www.hyva.com

or follow us on:



Hyva Holding B.V.
Antonie van Leeuwenhoekweg 37
2408 AK Alphen aan den Rijn
The Netherlands
Telephone: +31 (0)172 - 42 35 55
Telefax: +31 (0)172 - 42 08 80
info@hyva.com
www.hyva.com



Quality and
environmental certified

DEALER STAMP