



HYVA MOVING FLOOR



THE ULTIMATE MOVING FLOOR

HORIZONTAL LOADING-/UNLOADING SYSTEM

The Hyva Floor system is based on a moving floor principle, this means that the transport of the goods you want to unload or load from your trailer is actually done by the movement of the floor. The variation in friction between the floor and the product makes it possible to load and unload a wide variety of bulk materials and other goods; like pallets, bales and paper reels!

The enormous success of Hyva Floor's hydraulic operated drive units is based on a simple and easy to install system, suitable for all types of trailers and equipment. Besides the ultimate standard Hyva Floor system (HF500) which can virtually transport all products there are also dedicated Hyva Floor drive units and flooring available for special applications.

Development

By using the very latest engineering technology and state of the art components Hyva Floor is known as the most innovative manufacturer and supplier of moving floor systems in the world.

The Hyva Floor drive units are powered by hydraulics – the necessary sequence is done mechanically by internal valves which result that atmospheric conditions and dirt have absolutely no influence on the system's operation and performance. It is obvious that a number of factors are of fundamental importance to achieve a fast return on your capital investment. The Hyva Floor systems fulfill all the important factors, such as maximum cargo volume, lowest tare weight of your vehicle, low operational cost (maintenance free), durability, human safety and environmentally friendliness, sustainability and long lasting.

The latest Hyva Floor drive units meets all these requirements.



HF500 SLC



Highest quality Dutch and German made Heavy Duty cylinders



Double chromated solid piston rods



High pressure filter is standard



All valves/cylinders are protected against road dirt



Passivated hydraulic piping



The drive units are standard preserved against rust by the best Cathodic Dip Painting (CDP) process



The control valve is positioned at the outside of the trailer for easy access



Common-rail technology

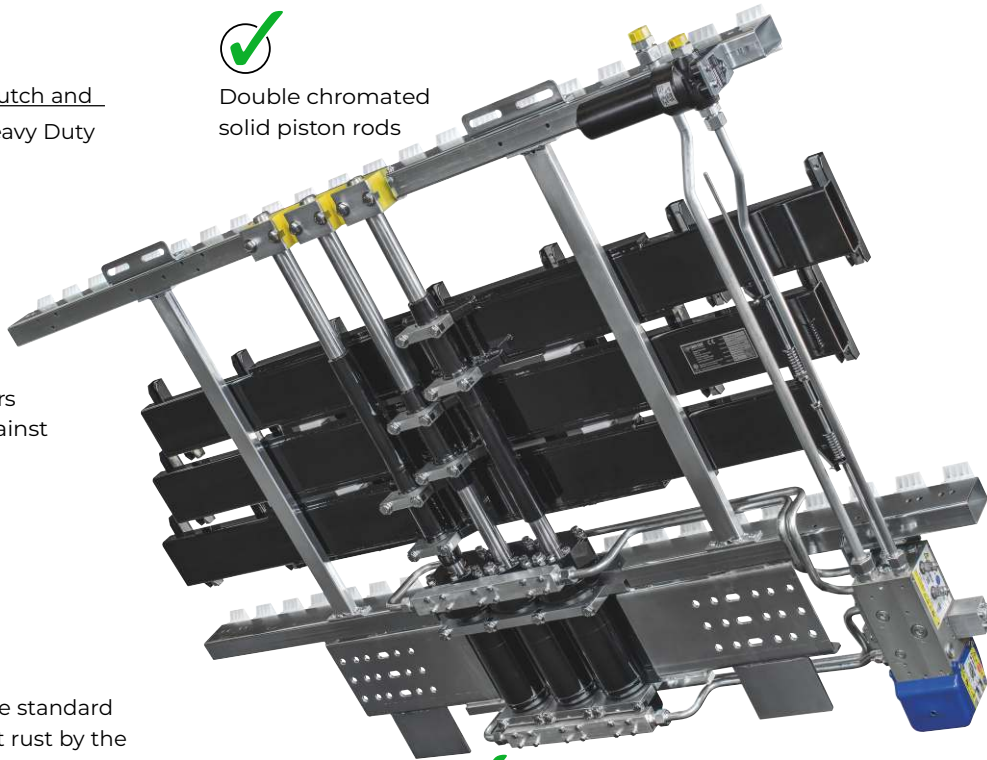

Sustainable environmental conservation: Because Hyva Floor fully preserves its drive units with a CDP finish, the system does not need to be repainted or refinished during its lifetime.

HF800 HD 80T 'HEAVY DUTY'

This extremely strong Hyva Floor 'moving floor' System is designed for the toughest applications in the market, using six cylinders that are interconnected by a massive piston rod. The Heavy Duty Hyva Floor 'moving floor' System has a net payload capacity of 80 T.

Yet, thanks to its unique design, the drive unit has remained lightweight, making the system readily mobile, especially for the mining industry as well as for mobile and stationary applications on industrial sites.

For intensive transport of highly abrasive materials, we recommend the use of our steel floor profiles, although aluminium floor profiles can also be used for such applications.

The Hyva Floor HF800 HD premiered worldwide in a trailer built by a Russian builder who supplied the trailer to Mongolia where it is used in the mining industry.



HOW IT WORKS

The Hyva Floor 'moving floor' System is a multi-functional, horizontal loading and unloading system for the fast and efficient transport of almost any product. The system is ideal for unloading a wide variety of bulk products, which typically are loaded from above and unloaded horizontally from the rear by the Hyva Floor 'moving floor' System. It can also be used to load and unload packed materials.

Floor structure

The Hyva Floor 'moving floor' System is composed of floor profiles installed lengthwise, parallel to each other. The Hyva Floor drive system moves the floor profiles back and forth within the power stroke of the three hydraulic cylinders. The cylinders are driven by mechanical or hydraulic systems (no electronics). The floor profiles are made primarily from aluminium, but they can also be supplied in steel or another material. The density between the floor profiles is ensured by a high-quality plastic sealing profile; Semi Leak Proof floors and even 100% Leak Proof solutions are available.

Clean unloading of bulk products

By using a moving partition, the floor/container can be unloaded in a virtually clean manner. The moving partition hangs from running rollers that are mounted on an integrated rail at the top of the side wall. A cloth, onto which the cargo is unloaded, is secured underneath the moving partition for moving the partition across the floor. But a cloth over the floor, instead of a moving partition, will do just as well. Do not forget to roll it back manually (for the sake of reliability, weight, costs) and hang it on the bulkhead for the next cargo.

Returning packed cargo

Besides bulk cargo, you can also load and unload a variety of packed cargo, such as: pallets, paper rolls, big bags, compressed bales, etc.

The Hyva Floor moving floor principle:

Step 1: three hydraulic cylinders move the entire floor as a whole in the selected direction, thereby transporting the cargo

Step 2: one hydraulic cylinder pushes one group of floor profiles (= 1/3 floor section) back underneath the cargo, while 2/3 of the floor section remains still, the cargo will hardly move as a result

Step 3: one hydraulic cylinder pushes one group of floor profiles (= 1/3 floor section) underneath the cargo, while 2/3 of the floor section remains still, the cargo will hardly move as a result

Step 4: one hydraulic cylinder pushes the third and last group of floor profiles (= 1/3 floor section) underneath the cargo, while 2/3 of the floor section remains still, the cargo will hardly move as a result

Step 1 is repeated again. The frequency and thus the speed at which these steps are repeated depend on the output of the hydraulic pump. The available power at which the cargo can be moved depends on the available pressure of the hydraulic pump. The Hyva Floor 'moving floor' System is designed for a maximum payload of 44 us tons / 40 tons.

The principle works in two directions, in other words the Hyva Floor 'moving floor' System can be used to LOAD and UNLOAD product.

Transportation speed (theoretical):

Standard 2,6 m/min. = unloading trailer 13.6 mtr. appr. 6-10 min. Powerspeed 4,8 m/min. = unloading trailer 13.6 mtr. appr. 3-5 min.

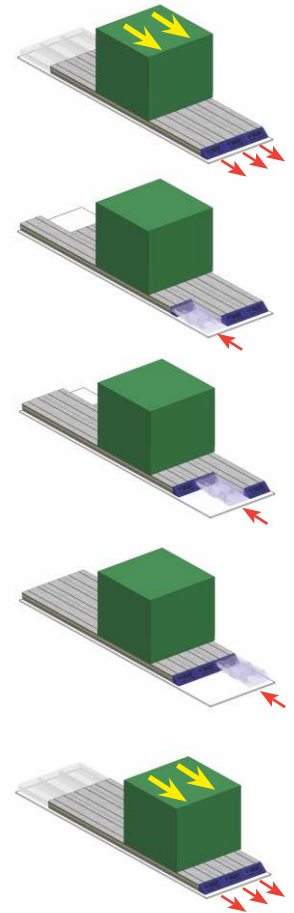

MODULAR OPERATING POSSIBILITIES



E
control

Manual override by means of a unique red "Hyva" rotary switch.



B
control



A
control

↑ Unique "S" detent mechanism in order to determine loading/stop/unloading position.

STANDARD



OPTIONAL



Thanks to its modular construction, the following operative versions of the Hyva Floor 'moving floor' System are possible (also retro fittable):

- E-control** With loading / stop / unloading over a switch as a standard provided with a manual override by means of a unique red "Hyva" rotary switch (Optional: radio remote control).
- B-control** With loading / stop / unloading over a manual handle, with unique "S" detent mechanism in order to determine loading / stop / unloading position. on / off switching over a switch As a standard provided with a manual override by means of a unique red "Hyva" rotary switch (Optional: radio remote control).
- A-control** With loading / stop / unloading over a manual handle, with unique "S" detent mechanism in order to determine loading / stop / unloading position (non-electrical).



THE HYVA FLOOR TRAILER

Floor mounting

Normally done by sliding in the floor profiles. Alternatively it can be done from above without the need of sliding. This can be useful in case of limited installation areas.



Endcaps safe + clean

The Hyva Floor system is supplied with endcaps angled 45 degrees to seal the ends of the aluminium floor profiles with the result that your vehicle is securely sealed on the rear side and no jamming can occur.

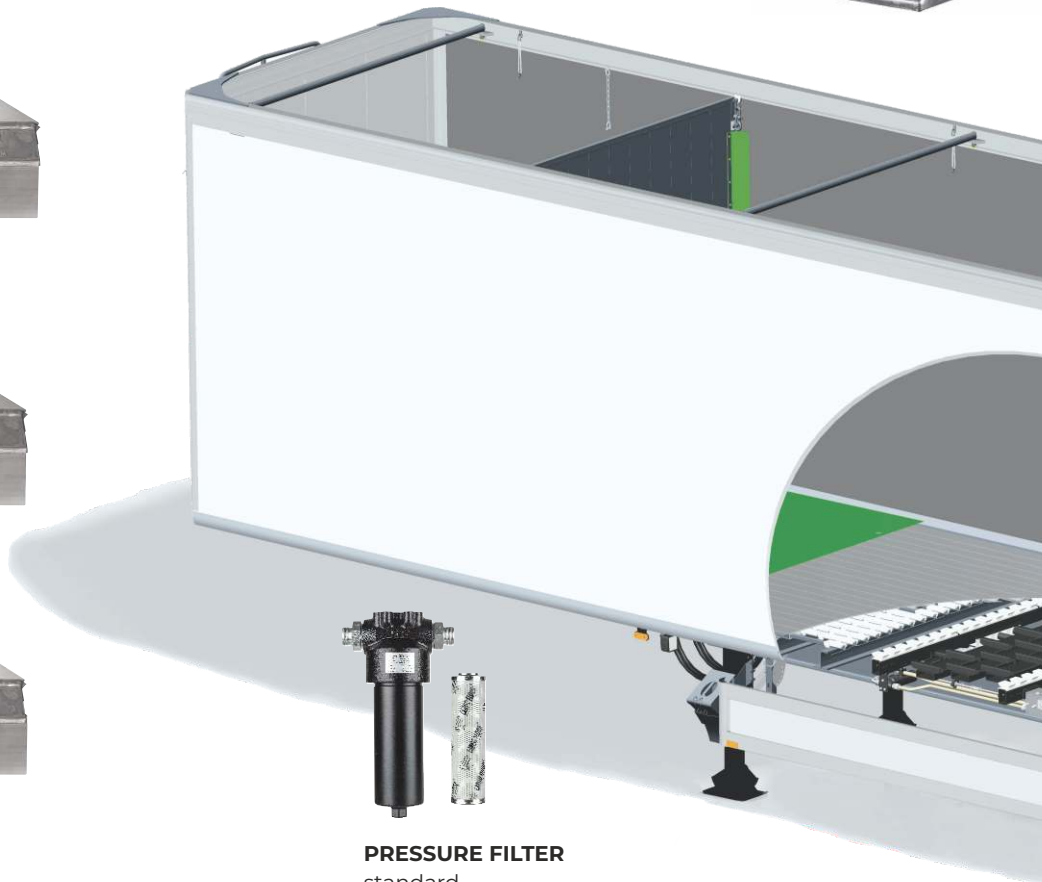

PRESSURE FILTER
standard

HYVA 'SNAP-ON' BEARING BLOCK

With this patented Hyva snap-on bearing block you can easily make a full length support and guidance and with the special integrated Anti-Splash lip, road dirt cannot enter or effect the subdeck and floor profiles.

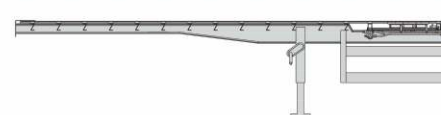
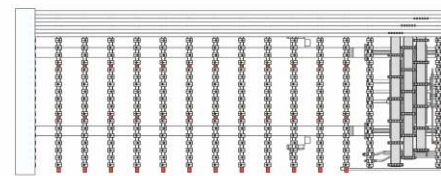
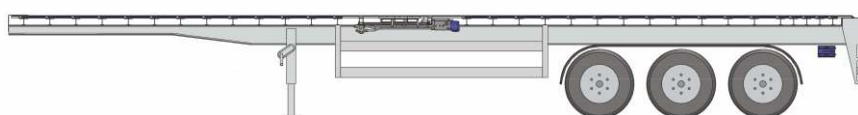
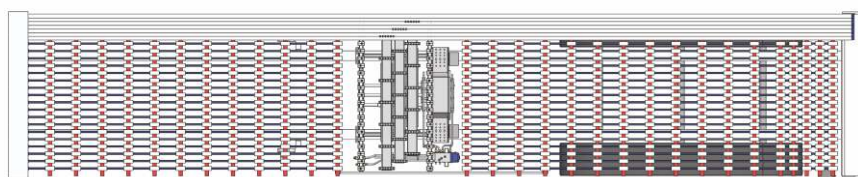
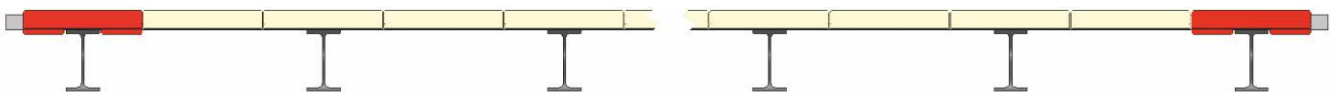

The seal between the floor profiles is of a unique plastic composite (Nobraforte) that will usually outlast the aluminum. The seal has been designed to ensure that the load cannot leak through the floor and blocks road dirt and splash water from entering into the trailer.

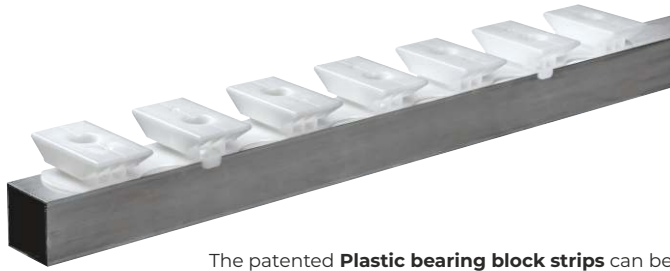

The patented **Plastic bearing block strips** can be mounted directly on top of the cross member and can be secured by screws or pop-rivets. No subdeck required!

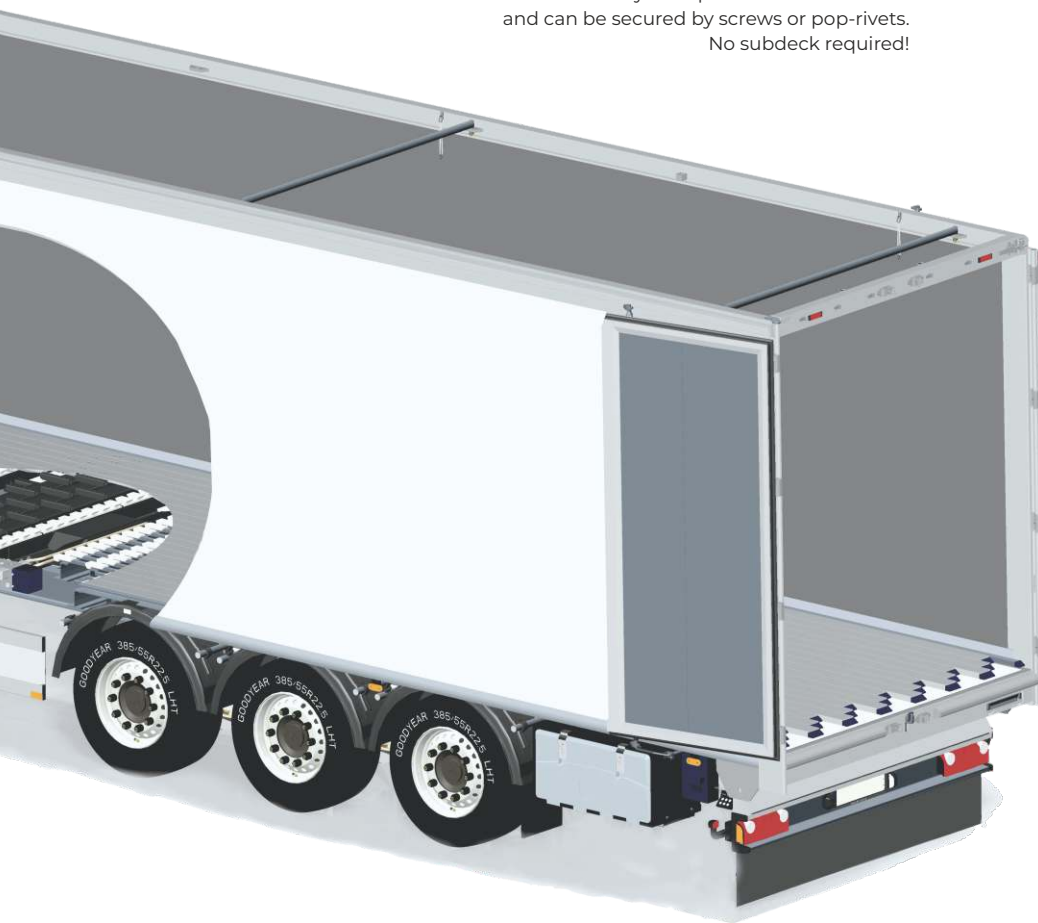

The patented TWISTER can be fitted easily and rapidly to the 25x25mm [1x1"] subdeck "tube"-or "U"-profile (supplied by the trailer builder); no tools are required.

By virtue of its **ingenious** construction the full weight on the aluminium floor profile is support by the thickest internal surface of the floor profile. Road dirt does not exert an influence on the useful life of the aluminium – and, moreover, the design provides for the maximum stability when subjected to heavy loads (largest sliding surface 8700mm² [13.5 sq"] each).

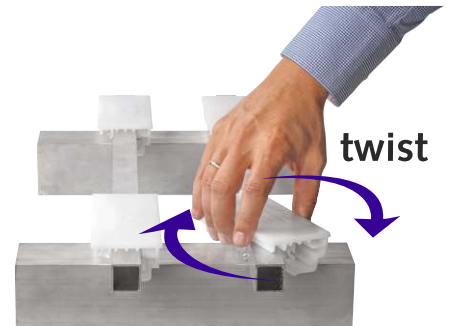
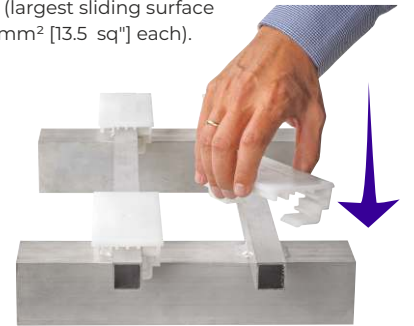

Anti Lifting Block

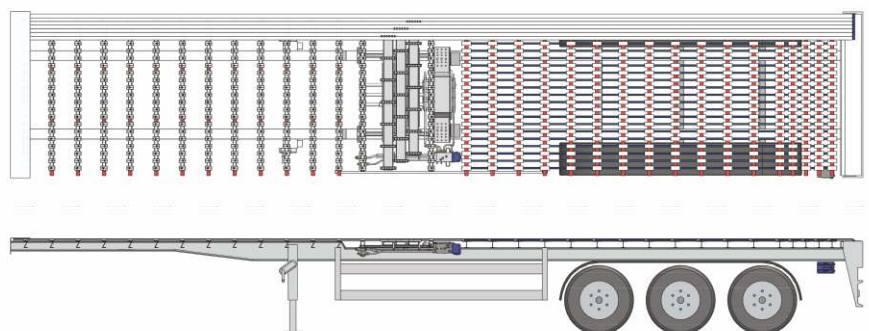
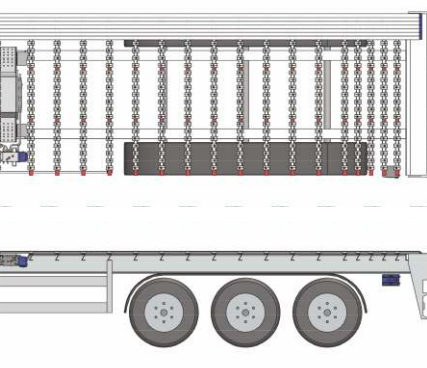
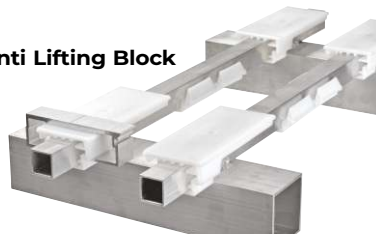

'SNAP-ON' BEARING BLOCK

This is a one-piece 'Snap-on' bearing block with anti-splash lip.

This newly developed 'Snap-on' plastic bearing block is a unique design with which a solid one-piece full length bearing strip can be created.

Injection moulding rather than extrusion was chosen for this process, as it achieves the high density and precise dimensional stability required. Despite the large surface of the one-piece 'Snap-on' bearing block, it exhibits extremely low friction and the very high wear resistance one has come to expect of the Hyva Floor bearing block.



Anti-Lifting/Hold-Down Block:

The unique hooks clamped into the support rail prevent the bearing block from vertically protruding from the rail, thereby holding the floor profiles in place at all times.

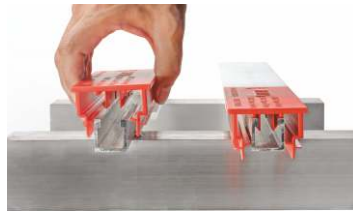

Anti-Splash lips:

The Anti-Splash Lip prevents road splash and debris from entering the support rail and contaminating the inside of the floor profiles, keeping wear to the bottom to a minimum.



Aluminum subdeck:

The special 25x25 [1x1"] aluminum U-shaped square section not only provides stability between the cross beams, it also serves as support and anti-lifting device for the plastic Hyva 'Snap-on' bearing block. This profile can also be used for other bearing blocks, such as the Hyva Twister.

This aluminum U-shaped profile can also be riveted on steel cross members.

Simple and ergonomically assembly:

- A) Press the 'Snap-on' bearing blocks vertically from above into the aluminium support rail.
- B) Slide the 'Snap-on' bearing blocks in the aluminium support rail (press a vertical stopper at each end of the rail to lock the bearing blocks in place).



APPLICATIONS

The standard Hyva Floor 'moving floor' System is ideally suited to the transport of almost all common products. In addition to the standard system, Hyva Floor also has a range of different drive units and floor sections available for special applications. The range of sections encompasses narrow or broad and ribbed or smooth sections in a variety of thicknesses. Sections are also available in a variety of materials (aluminium/steel/composite/plastic, or a combination of these materials).

Hyva Floor has proven its quality in the transports

bulk materials	Straw	Fertilizer
RDF (fluff)	Straw bales	Salt
Biomass	Maize	Chalk
Recyclables	Grain	Coal
Domestic waste	Potatoes	Waste paper
Green waste	Carrots	Rolls of paper
Wood chippings	Tapioca	Aluminium scrap
Sawdust	Milk powder	Cargo (bales / bags)
Bark	Coffee beans	Big bags
Logs of wood	Soya beans	Pallets
Potting soil	Alfalfa	Slaughter waste
Peat	Sugar beet and pulp	Sewage sludge
Clay	Chicken feed	Compressed bales
Bleaching earth	Manure	All agricultural products

When used in combination with the special automatic roll-up protection sheet (see pictures) the Hyva Floor can also be used for the trouble-free transport of the following products:

Glass	Sharp sand
Gravel	Vegetables and fruit
Ore	All other abrasive materials

Fork-lift truck

In principle all Hyva Floor floors can be driven on by a fork-lift truck; contact your body builder for information about the permitted weights!

Efficiency/output

Efficiency of loading and unloading (packed) cargo is determined mainly by the flatness and the even weight distribution of the cargo over the floor area of the Hyva Floor. Uneven weight distribution will reduce efficiency and may even cause the cargo to only move back and forth within the power stroke of the system. Uneven cargo weight distribution can be compensated by using supports to spread the weight evenly across the floor profiles.

The system's operating speed can also affect loading and unloading efficiency.



HF500 SLC LR-serie 'Leak Resist'

Because Hyva Floor is committed to leaving as small an environmental footprint as possible (leakage of products on the road is quickly considered an environmental crime), liquid-containing "waste" products must be transported in a safe and environmentally sound manner.

Hyva Floor has over 20 years of experience with its unique 100% watertight system solutions where a Hyva Floor drive system is mounted in the front of the trailer.

To make the Leak Proof concept easier and more accessible to a larger target group, Hyva Floor has developed a unique and special subdeck principle whereby the standard Hyva Floor under mount drive unit can as usual be mounted UNDER the floor. Tested for years, this special watertight subdeck concept has proven to be the ultimate solution in preventing leakage of liquid-containing products on the road.

Unlike the 100% Leak Proof system, the bodybuilder does not need to make any modifications to the vehicle for mounting the Hyva Leak Resist application. Besides a weight advantage, it also

delivers a high volume advantage, as the inclined sealing bulkhead wall is not required in this application.

With the supply of the unique Hyva Leak Proof Subdeck, a regular sub-floor will not be required anymore. The simple 'slide-in' system of the subdeck profiles makes installation fast and easy in both new and retrofit applications.

A solid bearing block is installed across the entire length of the floor under the moving floor profiles. What makes this unique is the fact that ABSOLUTELY NO end sealing section is used with this Leak Proof flooring solution. Also, the product will not come into contact with the solid under-floor bearing block during transport. There are currently two deck slat versions (moving floor profiles), the standard 7mm aluminium and the 10 mm heavy-duty aluminium model. Alternatively, you can also obtain for the STEEL profiles.

The space between the moving floor profiles is largely self-cleaning, but thanks to its open shape, it can be easily and efficiently cleaned with a broom or pressure washer.

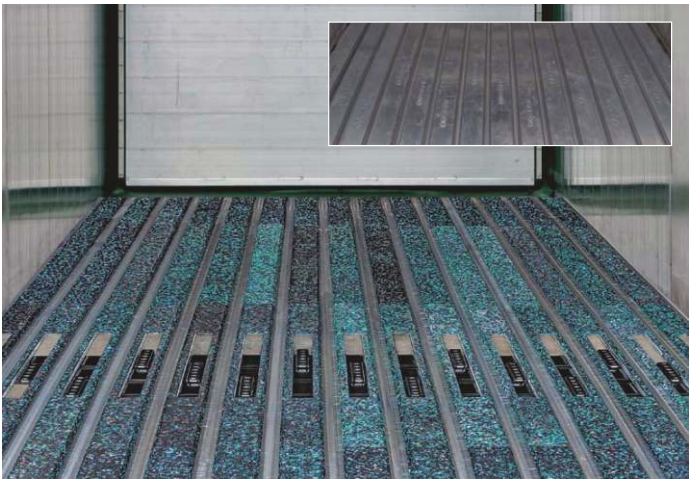

The Hyva Floor Leak Resist with under mount drive unit is the ultimate solution for protecting the environment from liquid-containing "waste" products during transport. All standard Hyva Floor drive units can be applied.

Important remark!

The LR-serie = leak resist and is NOT granted to be 100% Leak proof because of the under mount drive unit construction. Any leakage that may occur will only be possible and centrated at the connection area between the drive system and the floor profiles. A collector bin could avoid any spilling on the floor.



HF3 LP-2 LP-serie 'Leak Proof'



A compact waterproof system

This 100% leak proof Hyva Floor-system has been developed for transporting environment-polluting products, both in the form of loose bulk material as well as compressed bales.

The system is excellently suited for transporting and storing DOMESTIC WASTE and vegetation waste.

To achieve a 100% leak proof moving floor in your trailer you need to use a so called Front Mount Drive Hyva Floor system type HF3LP. Thanks to the unique and compact design and the use of space in the so-called head radius, which minimizes the loss of loading space. The inclined sealed partition also protects the drive system.

The aluminium sub-floor is easy to fit on both steel and aluminium chassis-frames, and is readily secured either by screws or rivets to the sub-floor members outside of the waterproof section.

Virtually no welding is required, since the sub-floor sections are simply slid into each other and becomes 100% waterproof with silicone sealant.



The aluminium floor sections are guided along their entire length, and are supported by solid plastic bearing blocks. Either standard aluminium section or HDI (Heavy Duty Impact) sections are available. The latter system is ideally suited to situations in which high impact forces are imposed on the floor.

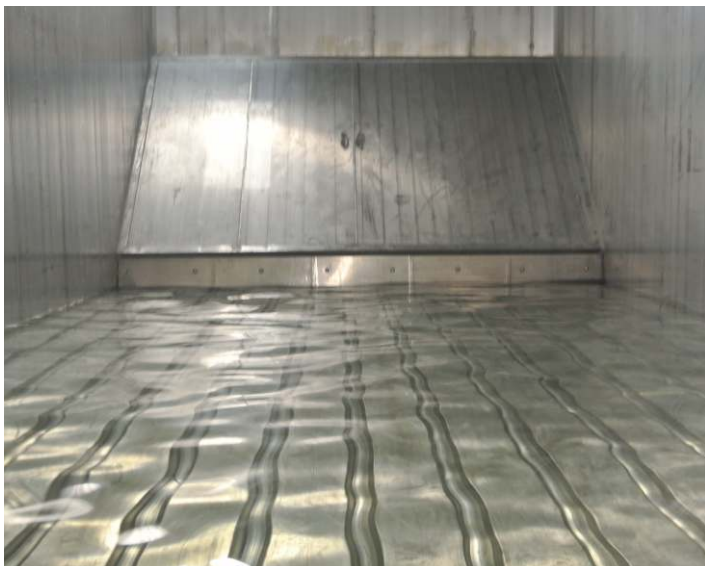

HF100 'Ultra Light'

This unique light-weight Hyva Floor-system has been developed especially for simple installation in trucks, drawbar trailers, containers and inter-changeable containers (demountables).

A few characteristics of the HF100 system:

- Lowest installation height possible in combination with 80 mm cross member
- Extremely low intrinsic weight of the power unit
- Floor speeds between 0-2.5 metres / min.
- The entire hydraulic drive is controlled solely by mechanical/hydraulic means.
- The pre-assembly of the cylinders, pipes and valves in a compact frame ensures a very simple and rapid installation
- Floor construction identical to the standard Hyva Floor-system
- Sub-frame may be dropped, in which case the hydraulic drive can be integrated in your own structure (for example aluminium/composite)
- Enables the maximum cargo volume to be utilized
- Suited for use as an autonomous metering silo
- Maximum load 20 tonnes
- Maximum floor length 9,000 mm
- Passivated hydraulic piping



CDP preserved moving cross members (standard)

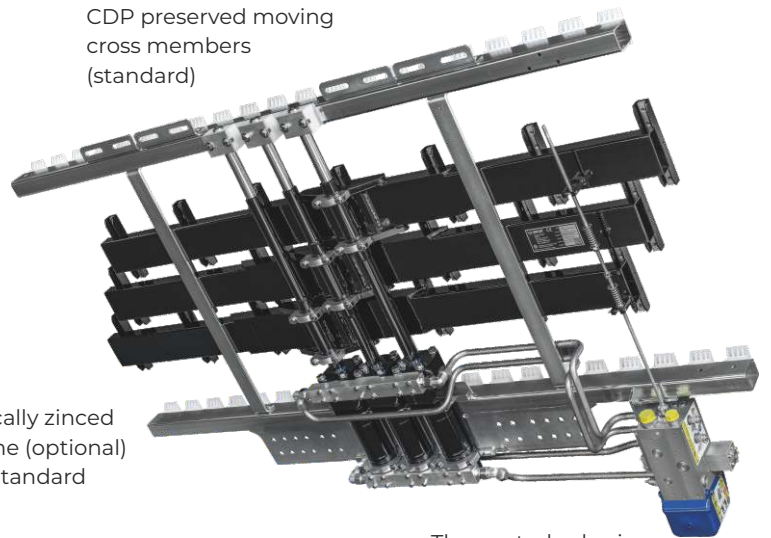

Thermally zinced subframe (optional)
CDP is standard

The control valve is standard positioned outside the chassis, because of that it is simply accessible



HF500 SLC Hyva Bulkrunner

The Bulkmover is the smart solution for transport of bulk products.

Mainly for loose product

Because the floor profiles of the Hyva Bulkrunner are wider than the standard 21 floor profile execution this concept is not suitable for the loading and unloading of pallets and paper reels with the help of the floor movement of the Hyva Floor system. Of course pallets eg. can be loaded - and unloaded - by driving a hand pallet truck or fork lift truck over the floor.







More than 20 years of experience with the wide floor profiles, mainly in stationary factory applications, has proven that the 15 floor profile version of the Hyva Floor system is extremely suitable for the efficient unloading of most common loose products in large volumes.

Weight reduction

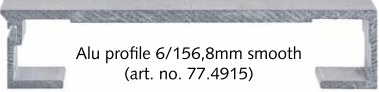
In order to reduce weight in a safe and reliable way Hyva Floor has developed an alternative floor: an execution which has 15 floor profiles instead of the usual 21. The total moving floor surface is exactly equal to the the 21 moving floor profiles, because of which no adjustment of the side profile is needed.



HYVA BULKRUNNER 15 PROFILES

Profile type	Clarification
 <p>Alu profile 6/156,8mm smooth (art. no. 77.4915)</p>  <p>Non moving sideprofiles</p>	<p>Completely smooth for product protection extreme light weight</p> <p>This smooth profile has a balanced weight and strong proportion to make it suitable for transporting almost every product. The unique shaped seal can be pulled in the profile to avoid leakage and protect the transported product against road dirt and water splash. The seal itself is also protected by the shape of the profile. To seal both sides of the moving floor surface one double seal profile is provided. With this double seal profile the floor can be easily turned after several years, to extend the life time. This profile can be mounted on most of the plastic bearing blocks and sub decks available.</p> <p>The plastic bearings underneath are protected by and enclosed within the shape of the aluminum profile, this gives an excellent stability to the floor profile and is also protected against street dirt. The enormously large support and bearing surface provides an extremely long lifespan. For safe and clean emptying the trailer, all floor profiles will be sealed with an end cap in aluminum. The profiles are maintenance free, however cleaning with a high pressure steam cleaner is permitted without any concessions. The width of the profiles is engineered so that enough space remains for two fixed side profiles in which approved cargo lashing eyes can be mounted. The profile is 100 % recyclable and keeps a certain residual value. Also available in 10 mm.</p> <p>The profile is NOT suitable for the transport of pallets and packaged goods by the movement of the floor.</p>
 <p>Alu profile 8/20-156,8mm HD (art. no. 79.5208)</p>	<p>A dedicated Heavy Duty profile</p> <p>This profile is a so called dedicated profile. This means that the profile is especially designed for the transport of special (mostly extreme) products. Because of the two protruding round merlons this profile has a very high impact resistance and the special round shape makes it easy to clean. Moist and dusty parts flow back into the so called barrel shape, so moist, mud and dust can simply be drained to the outside and almost no leakage through the floor occurs. This also protects the seal. Because of the low weight a perfect pay load ratio remains. The profile is NOT suitable for the transport of pallets and packaged goods by the movement of the floor.</p>
 <p>Alu profile 10/22-156,8mm XHDI (art. no. 81.5440)</p>	<p>XHDI (X-treme Heavy Duty Impact)</p> <p>This profile is a so called dedicate profile. This means this is a profile that has been especially designed for the transport of special (mostly extreme) products. Because of the three protruding round merlons this profile has a very high impact resistance and the special round shape makes it easy to clean. Moist and dusty parts flow back into the so called barrel shape gutters, so moist, mud and dust can simply drain to the outside and will hardly leak through the floor. This also protects the seal extra. Because of the low weight a perfect pay load ratio remains. This profile is less suitable for the transport of pallets and packaged goods, these need to be loaded and unloaded with the help of a fork lift truck.</p>
 <p>Alu profile 11/33-156,8mm HD seals (art. no. 83.5533)</p>	<p>HD seals</p> <p>This profile is a so called dedicate profile. This means this is a profile that has been especially designed for the transport of special (mostly extreme) products. Because of the two protruding round merlons this profile has a very high impact resistance and the special round shape makes it easy to clean. Moist and dusty parts flow back into the so called barrel shape, so moist, mud and dust can simply drain to the outside and will hardly seep through the floor. Because of the low weight a perfect pay load ratio remains. This profile is NOT suitable for the transport of pallets and packaged goods, not even with the help of a fork lift truck!</p>
 <p>Alu 10/133mm Leak Proof deckslat HD (Heavy Duty) (art. no. 89.3497)</p>	<p>LR/LP deckslat</p> <p>This profile is specially designed for the leak proof and leak resist applications of the Hyva Floor. It fits over a full length solid plastic bearing strip and can't lift away. There remains a channel inbetween the moving slats to make high pressure cleaning possible. The profile can only be combined with a special T-subdeck. The total configuration of the T-subdeck, solid bearing block and this deckslat profile makes the highest resistance against high impact! It is not suitable for carrying fine materials and pallets. Also available in a 7mm. light weight version.</p>

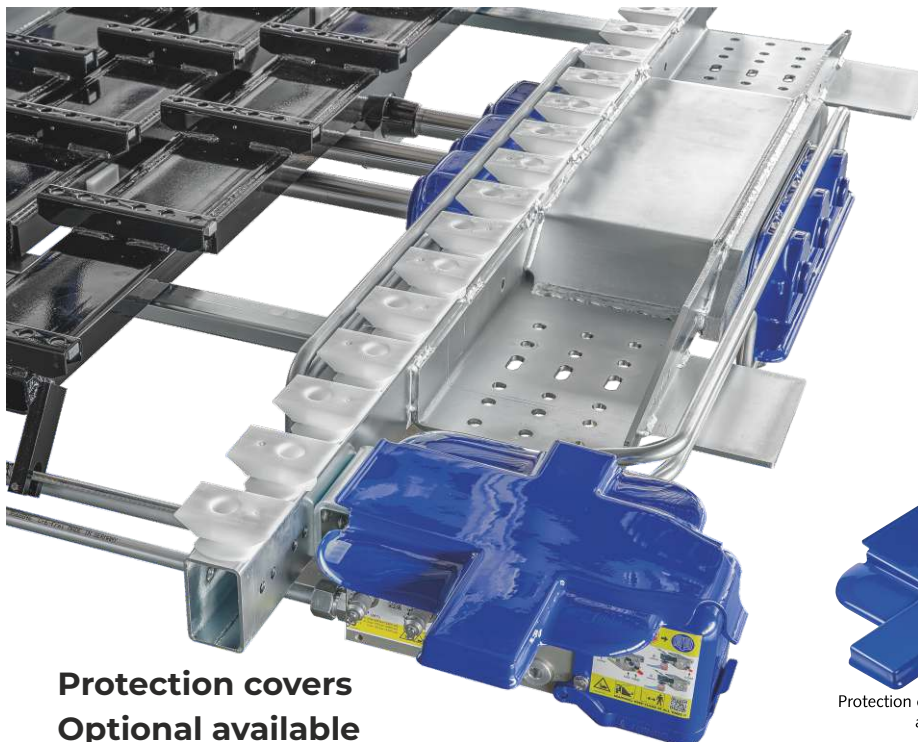

Protection covers
Optional available



Protection cover cylinder bottom side
art. no. 7371053



Protection cover cylinder rod side
art. no. 7371052











Protection cover control valve top side
art. no. 7371054



Protection cover control valve rear side
art. no. 7371051
RHD art. no. 7371055

STANDARD HYVA FLOOR 21 PROFILES

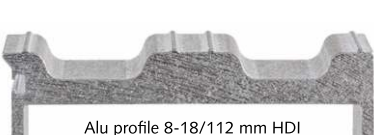
Profile type	Clarification
 <p>Alu profile 6/112mm ribbed (art. no. 20.0360)</p>  <p>Alu profile 6/112mm-DS ribbed (art. no. 21.0549)</p>	<p>The ultimate standard.</p> <p>The balanced weight and strong proportions makes this profile suitable for almost every product that needs to be transported. The ribs are only meant to provide traction and guidance to the product (mainly to avoid twisting of pallets). The unique shaped seal can be pulled in the profile to avoid leakage and protect the transported product against road dirt and water splash. The seal itself is also protected by the shape of the profile. To seal both sides of the moving floor surface one double seal profile is provided. With this double seal profile the floor can be easily turned after several years, to extend the life time. This profile can be mounted on most of the plastic bearing blocks and sub decks available.</p> <p>The plastic bearings underneath are protected by and enclosed within the shape of the aluminum profile, this gives an excellent stability to the floor profile and is also protected against street dirt. The enormously large support and bearing surface provides an extremely long lifespan. For safe and clean emptying the trailer, all floor profiles will be sealed with an end cap in either plastic or aluminum. The profiles are maintenance free, however cleaning with a high pressure steam cleaner is permitted without any concessions. The width of the profiles is engineered so that enough space remains for two fixed side profiles in which approved cargo lashing eyes can be mounted. The profile is 100 % recyclable and keeps a certain residual value.</p>
 <p>Alu profile 6/112mm smooth (art. no. 22.0547)</p>	<p>Completely smooth for product protection</p> <p>This smooth profile is almost identical with regards to the shape and weight to the 6 mm. standard profile, with the exception that the two top ribs have been omitted. This has been done in order to prevent damages to products. If the floor has been mounted correctly this profile has the same excellent qualities as the 6 mm. standard profile. This profile is very suitable for the transport of paper reels and agricultural products.</p>
 <p>Alu profile 8/112 mm ribbed (art. no. 24.3752)</p>	<p>The compromise between weight and impact.</p> <p>This "in between" profile has the same shape and qualities as the 6 mm. standard profile. The only difference is that this profile is 2 mm. thicker. This results in even more stability, better suitable for more intense use whereas the risk of deformation of the profile due to product impact onto the floor or driving over the floor with a fork lift truck is reduced. If one can overlook the weight increase we certainly would advice this profile.</p>
 <p>Alu profile 8/112 mm smooth (art. no. 37.1505)</p>	<p>The compromise between weight and impact combined with product protection</p> <p>This "in between" profile has the same shape and qualities as the 6 mm. smooth profile. The only difference is that this profile is 2 mm. thicker. This results in even more stability, better suitable for more intense use whereas the risk of deformation of the profile due to product impact onto the floor or driving over the floor with a fork lift truck is reduced. If one can overlook the weight increase we certainly would advice this profile.</p>
 <p>Alu profile 10/112 mm ribbed (art. no. 25.0550)</p>	<p>The heavy duty allrounder</p> <p>Impact, wear resisting and driving over this profile, nothing is too much for this profile. The profile itself has the same specifications as the 6 mm. standard profile but this profile is 4 mm thicker can be used for the transport of almost any product or machine. Only the extra weight and extra cost of this profile could make you choose another profile.</p>
 <p>Alu profile 10/112 mm smooth (art. no. 27.0552)</p>	<p>The heavy duty allrounder with product protection.</p> <p>Impact, wear resisting and driving over this profile, nothing is too much for this profile. The profile itself has the same specifications as the 6 mm. smooth profile but this profile is 4 mm thicker can be used for the transport of almost any product or machine. Only the extra weight and extra cost of this profile could make you choose another profile.</p>
 <p>Alu 8/112mm SLP ribbed (art. no. 72.2988)</p> <p>(possible with SLP-channel (art. no. 755.4525))</p>	<p>SLP the Semi Leak Proof profile</p> <p>This is a profile, as the name already mentions, which is almost leak proof. The profile is just as all round as the 8 and 10 version but as an extra feature: moist products cannot leak through the floor directly. Liquids leak into a special gutter. This gutter can be exchanged and can be simply removed out of the floor for cleaning when necessary. This profile does require a small adjustment to the head board. The profile is very suitable for the transport of fine or moist products that may not leak onto the surface when loading, driving or unloading. However it is never meant as leak proof, for this we recommend the LR-/LP series.</p>
 <p>Alu profile 8-20/112 mm HD (art. no. 31.1197)</p>	<p>A dedicated Heavy Duty profile</p> <p>This profile is a so called dedicated profile. This means that the profile is especially designed for the transport of special (mostly extreme) products. Because of the two protruding round merlons this profile has a very high impact resistance and the special round shape makes it easy to clean. Moist and dusty parts flow back into the so called barrel shape, so moist, mud and dust can simply be drained to the outside and almost no leakage through the floor occurs. This also protects the seal. Because of the low weight a perfect payload ratio remains. The profile is less suitable for the transport of pallets and packaged goods.</p>
 <p>Alu profile 8-18/112 mm HDI (art. no. 30.0695)</p>	<p>The extreme dedicated Heavy Duty Impact profile</p> <p>This profile is a so called dedicated profile. This means this is a profile that has been especially designed for the transport of special (mostly extreme) products. Because of the three protruding round merlons this profile has an unbelievable high impact resistance, that can be compared with construction steel. The round shapes makes it easy to clean. Moist and dusty parts flow back into the so called channels, so moist, mud and dust can simply be drained to the outside and almost no leakage through the floor occurs. This also protects the seal. Because of the low weight a perfect payload ratio remains. The profile is less suitable for the transport of pallets and packaged goods.</p>

TECHNICAL SPECS

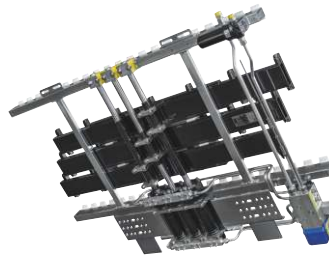

	Type	HF500 SLC-3.9 (Power Speed)*				HF600 HDC-4.7	
		Metric		US/Imperial		Metric	US/Imperial
Weight (from)	kg / lbs	450		992		538	1186
Available in Hyva Bulklover execution		yes	(yes)*	yes	(yes)*	yes	yes
Operating possibilities		E/B/A	(B/A)*	E/B/A	(B/A)*	E/B/A	E/B/A
Cylinder bore	mm / inch	100		3,9		120	4,7
Piston rod diameter	mm / inch	45		1,8		45	1,8
Working stroke	mm / inch	200		7,9		200	7,9
Cylinder volume	ltr / US gallon	2,82		0,7		4,2	1,1
Oil volume per cycle	ltr / US gallon	8,45		2,2		12,6	3,3
Working pressure	bar / PSI	170		2466		130	1885
Max. pressure	bar / PSI	225		3263		205	2973
Advised oil flow per minute	ltr / US gallon	110	(180)*	29	(48)*	110	29
Max. oil flow per minute	ltr / US gallon	130	(200)*	34	(53)*	190	50
Pressure filter	µm / micron	10		(2x10)*		10	10
Speed at advised oil flow per minute	mtr / ft	2,6	(4)*	8,5	(13,1)*	1,7	5,6
Speed at max oil flow per minute	mtr / ft	3,1	(4,7)*	10,2	(15,4)*	3,0	9,8
Theoretical unloading time trailer 13.6mtr/45 ft	min / min	6	(3)*	6	(3)*	9	9
Max. loading capacity	ton / lbs	40		88185		50	110231
Max. loading capacity	ton / US ton	40		44		50	55
Advised pump capacity (2-line system):							
Flow per minute	ltr / US gallon	110	(180)*	29	(48)*	110	29
Pressure	bar / PSI	250		3626		220	3191
Pressure piping diameter	mm / inch	20x2	(25x2)*	1x0.08	(1x0.08)*	25x2	1x0.08
Return piping diameter	mm / inch	25x2	(30x2)*	1x0.08	(1"x0.08)*	25x2	1x0.08
Oil tank filling at advised flow	ltr / US gallon	110	(180)*	29	(48)*	100	26
Oil tank filling at max. flow	ltr / US gallon	130	(200)*	34	(53)*	190	50
Max. oil temperature	°C / °F	70		158		70	158

Oil type: mineral and biological (HEES)

Normal temperature range -15 < 30 °C / 5 < 86 °F ISO VG32

Low temperature range -25 < 0 °C / -13 < 32 °F ISO VG22

High temperature range 15 < 40 °C / 59 < 104 °F ISO VG46



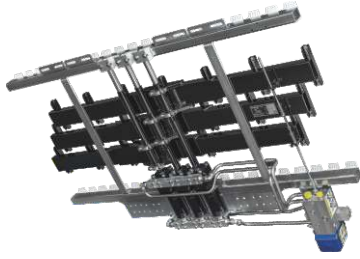

HF100 SLL-3.1

<i>Metric</i>	<i>US/Imperial</i>
295	650
yes	yes
E/B/A	E/B/A

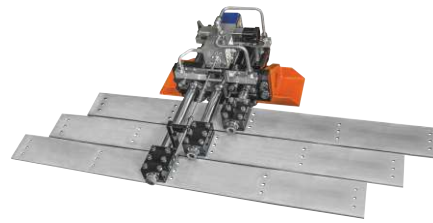

HF3 LP-4.9

<i>Metric</i>	<i>US/Imperial</i>
310	683
yes	yes
E/B/A	E/B/A

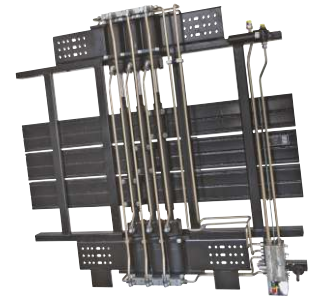

HF800 HD-6 cyl.

<i>Metric</i>	<i>US/Imperial</i>
1038	2288
yes	yes
E/B/A	E/B/A

80	3,1	125	4,9	100	3,9
35	1,4	60	2,4	50	2,0
150	5,9	150	5,9	200	7,9
1,36	0,4	3,26	0,9	5,5	1,5
4,09	1,1	9,77	2,6	16,5	4,4
130	1885	125	1813	170	2466
175	2538	150	2176	225	3263
70	18	130	34	110	29
80	21	170	45	130	34
10	10	10	10	10	10
2,6	8,5	2,0	6,6	1,3	4,3
2,9	9,5	2,6	8,5	1,6	5,2
n.v.t.	n.v.t	7	7	12	12
20	44092	35	77162	80	176370
20	22	35	39	80	88
70	18	110	29	110	29
200	2901	175	2538	250	3626
20x2	1x0.08"	20x2	1x0.08"	20x2	1x0.08"
25x2	1x0.08"	25x2	1x0.08"	25x2	1x0.08"
70	18	130	34	100	26
80	21	170	45	130	34
70	158	70	158	70	158



110 countries
+3,500 employees
20,000 customers
+30 subsidiaries
14 production facilities



Hyva is a leading provider of innovative and highly efficient transport solutions for commercial vehicles used in transport, construction, mining, materials handling and environmental service industries.

Founded in 1979 in the Netherlands, the company has a global presence with more than 30 wholly owned subsidiaries, extraordinary service coverage and 14 manufacturing facilities in Brazil, China, Europe and India.

For more information on Hyva, please visit www.hyva.com

or follow us on:



Hyva Holding B.V.
Antonie van Leeuwenhoekweg 37
2408 AK Alphen aan den Rijn
The Netherlands
Telephone: +31 (0)172 - 42 35 55
info@hyva.com
www.hyva.com



Quality and
environmental certified

DEALER STAMP